

1

2

3

4

# HISTORIQUE DES REVISIONS

REVISION			DESCRIPTION	DOCUMENT DE REFERENCE	VERIFICATION	
INDICE	DATE	AUTEUR			DATE	AUTEUR
V 3 0 0	17/11/2014	O A L	2014H2 board package		17/11/2014	O A L

Designer:	Date:	Vérification:	Date:	Approval:	Date:
<b>PLDA GROUP</b> Parc Club du Golf Bâtiment 11 Rue Guilibert 13856 Aix-En-Provence Cedex 3 FRANCE Tel: +33 (0) 442 393 600 Fax: +33 (0) 442 394 902 www.pldagroup.com		Project Name		DESIGNATION	
		XpressK7		ENTETE	
		Product Reference	Page	VERSION	
		P130	1/30	DATE	AUTHOR
			19/03/2014	M.C.P.	V.2.2.0

These schematics are PLDA GROUP property. They must be not reproduced or shared without PLDA GROUP written authorization. Copyright PLDA GROUP 2011. All rights reserved

1

2

3

4

A

B

C

- 1 ENTETE
- 2 INDEX
- 3 SYNOPTIQUE
- 4 ALIMENTATIONS
- 5 ALIM +1V8 +VCCAUX\_IO
- 6 ALIM +VCCINT +VCCBRAM
- 7 ALIM +MGTAVCC +MGTVTT
- 8 ALIM +VADJ +3V3
- 9 ALIM DDR3 VBAT
- 10 KINTEX7
- 11 KINTEX7 CONFIG
- 12 KINTEX7 BANK 12 13
- 13 KINTEX7 BANK 14 15 16
- 14 KINTEX7 BANK 32 33
- 15 KINTEX7 BANK 34
- 16 KINTEX7 TRANSCEIVER
- 17 KINTEX7 POWER SUPPLY
- 18 KINTEX7 GND
- 19 KINTEX7 DECOUPLAGES
- 20 PCI EXPRESS
- 21 FLASHPROM BPI
- 22 FMC HPC
- 23 FMC A B
- 24 FMC C D
- 25 FMC E F
- 26 FMC G H
- 27 FMC J K
- 28 DDR3 SODIMM
- 29 PROTOCORE
- 30 MISC

Designer:	Date:	Vérification:	Date:	Approval:	Date:	
<b>PLDA GROUP</b> Parc Club du Golf Bâtiment 11 Rue Guilibert 13856 Aix-En-Provence Cedex 3 FRANCE Tel: +33 (0) 442 393 600 Fax: +33 (0) 442 394 902 www.pldagroup.com		Project Name		DESIGNATION		
		XpressK7		INDEX		
		Product Reference	Page	VERSION		
		P130	2/30	DATE	AUTHOR	INDICE
		19/03/2014		M.C.P.	V.2.2.0	

These schematics are PLDA GROUP property. They must be not reproduced or shared without PLDA GROUP written authorization. \_ Copyright PLDA GROUP 2011. All rights reserved

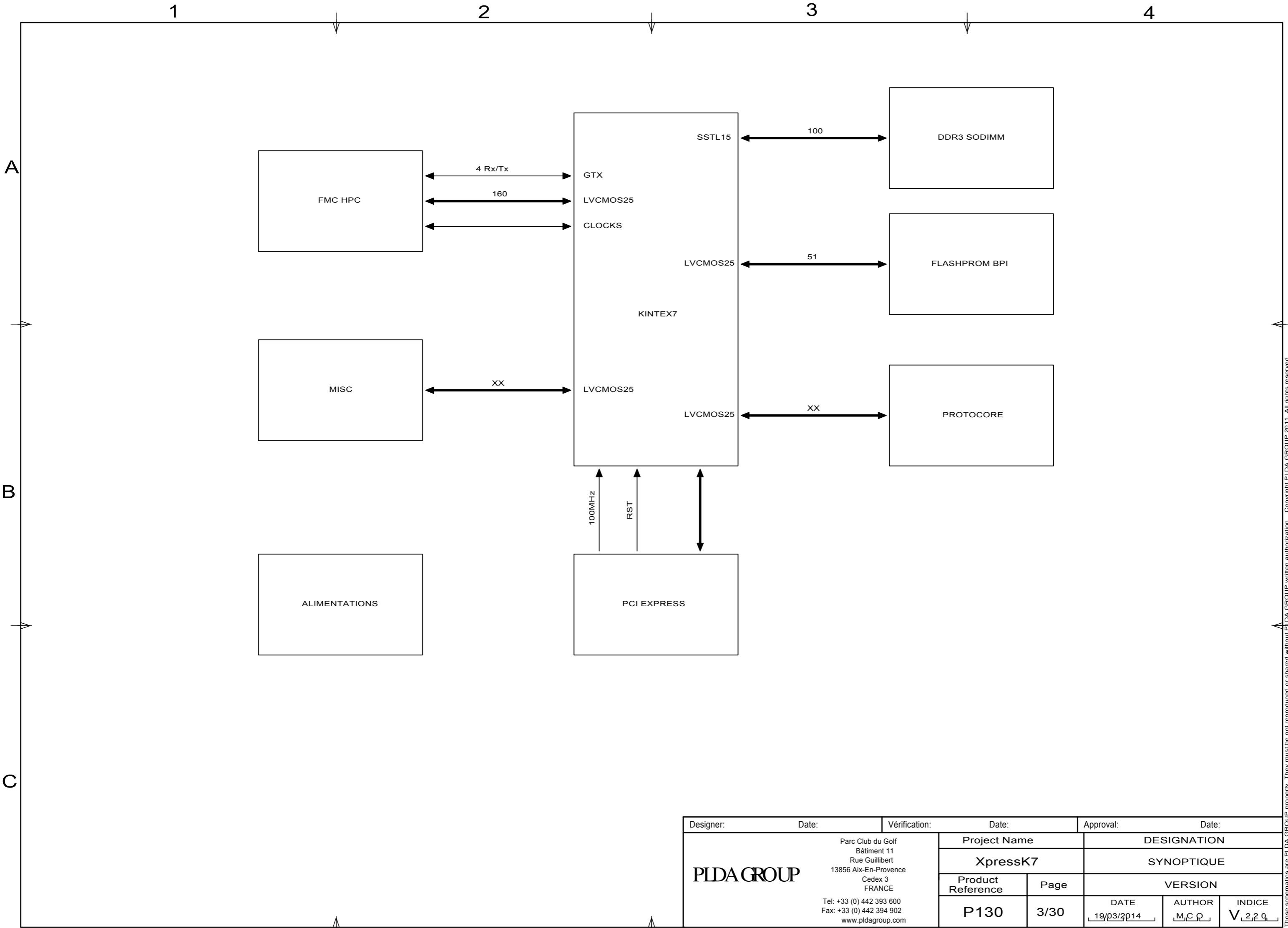

A

B

C

1

2

3

4

Designer:	Date:	Vérification:	Date:	Approval:	Date:
<b>PLDA GROUP</b> Parc Club du Golf Bâtiment 11 Rue Guillibert 13856 Aix-En-Provence Cedex 3 FRANCE Tel: +33 (0) 442 393 600 Fax: +33 (0) 442 394 902 www.pldagroup.com	Project Name		DESIGNATION		
	XpressK7		SYNOPTIQUE		
	Product Reference	Page	VERSION		
	P130	3/30	DATE	AUTHOR	INDICE
		19/03/2014	M.C.P.	V.2.2.0	

These schematics are PLDA GROUP property. They must be not reproduced or shared without PLDA GROUP written authorization. Copyright PLDA GROUP 2011. All rights reserved

1

2

3

4

A

B

C

ALIM +1V8 +VCCAUX\_IO

ALIM +VCCINT +VCCBRAM

ALIM +MGTAVCC +MGTVTT

ALIM +VADJ +3V3

ALIM DDR3  
VBAT

Designer:	Date:	Vérification:	Date:	Approval:	Date:
<b>PLDA GROUP</b> Parc Club du Golf Bâtiment 11 Rue Guilibert 13856 Aix-En-Provence Cedex 3 FRANCE Tel: +33 (0) 442 393 600 Fax: +33 (0) 442 394 902 www.pldagroup.com	Project Name		DESIGNATION		
	XpressK7		ALIMENTATIONS		
	Product Reference	Page	VERSION		
	P130	4/30	DATE	AUTHOR	INDICE
		19/03/2014	M.C.P.	V.2.2.0	

These schematics are PLDA GROUP property. They must be not reproduced or shared without PLDA GROUP written authorization. Copyright PLDA GROUP 2011. All rights reserved

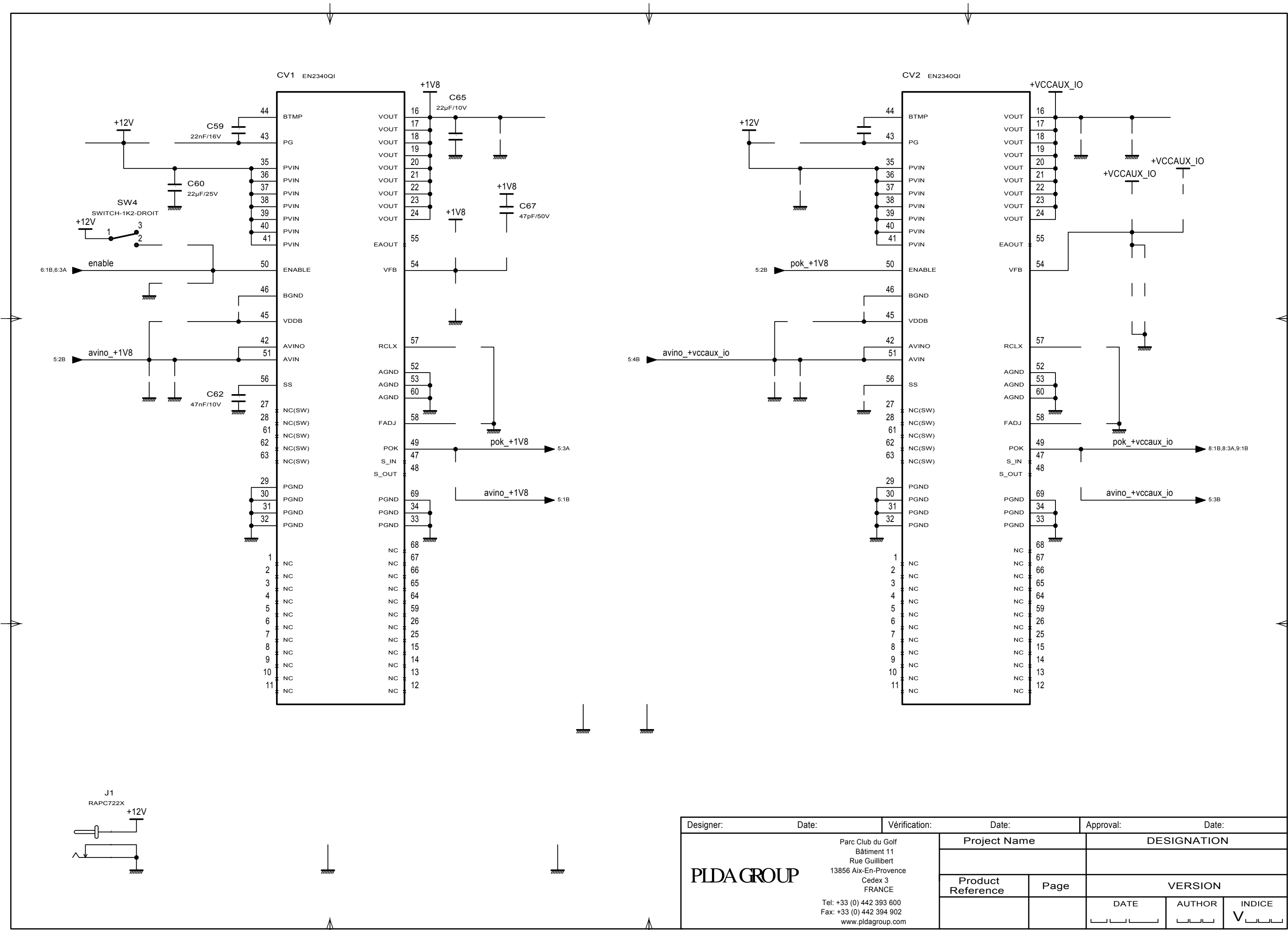

These schematics are PLDA GROUP property. They must be not reproduced or shared without PLDA GROUP written authorization. Copyright PLDA GROUP 2011. All rights reserved.

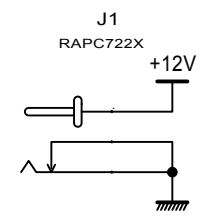

Designer:	Date:	Vérification:	Date:	Approval:	Date:
<b>PLDA GROUP</b> Parc Club du Golf Bâtiment 11 Rue Guilibert 13856 Aix-En-Provence Cedex 3 FRANCE Tel: +33 (0) 442 393 600 Fax: +33 (0) 442 394 902 www.pldagroup.com		Project Name		DESIGNATION	
		Product Reference	Page	VERSION	
		DATE	AUTHOR	INDICE	
		____	____	V____	

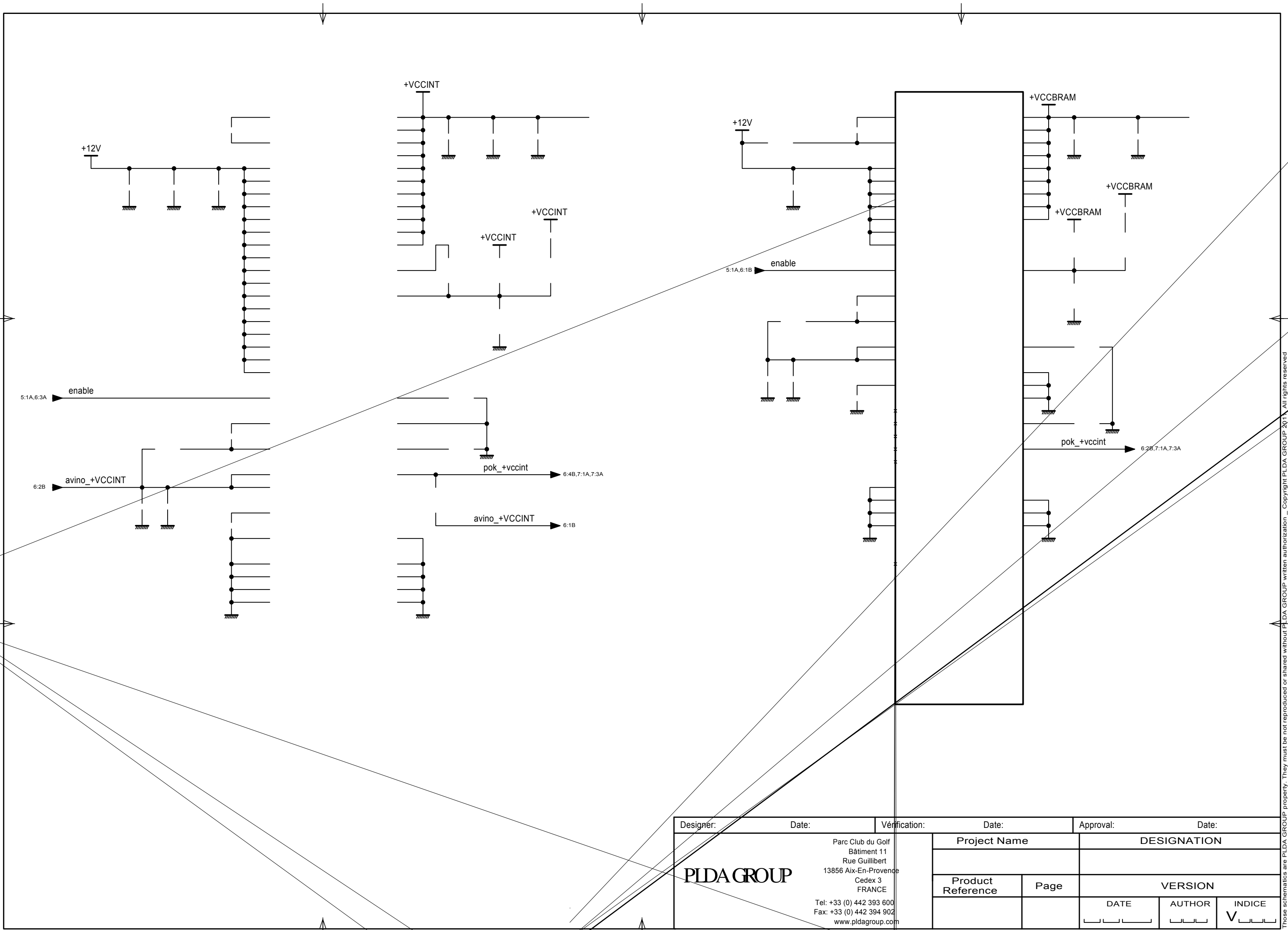

These schematics are PLDA GROUP property. They must be not reproduced or shared without PLDA GROUP written authorization - Copyright PLDA GROUP 2011. All rights reserved

Designér:	Date:	Vérification:	Date:	Approval:	Date:
<b>PLDA GROUP</b> Parc Club du Golf Bâtiment 11 Rue Guilibert 13856 Aix-En-Provence Cedex 3 FRANCE Tel: +33 (0) 442 393 600 Fax: +33 (0) 442 394 902 www.pldagroup.com		Project Name		DESIGNATION	
		Product Reference	Page	VERSION	
				DATE	AUTHOR
				_____	_____
				INDICE	V _____

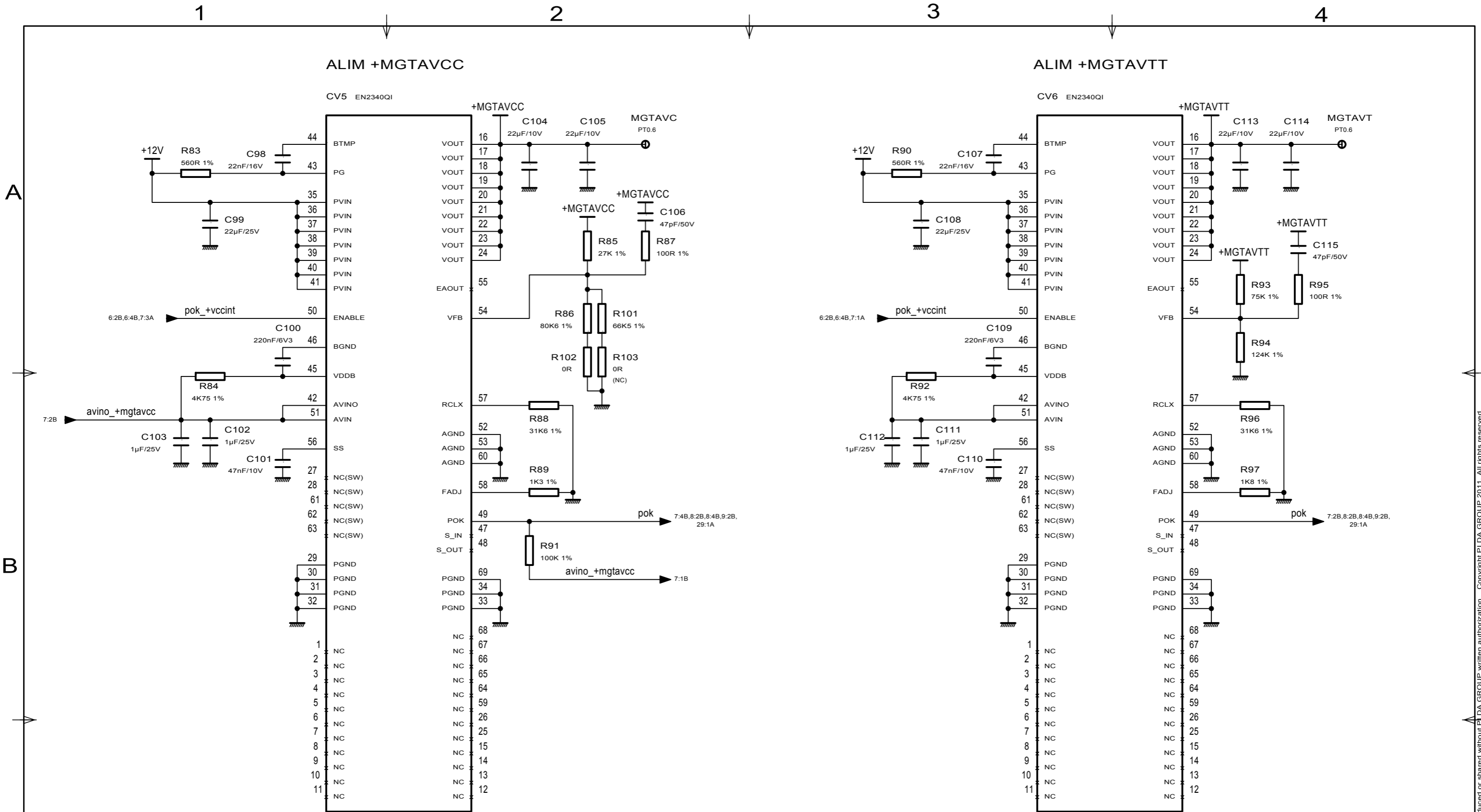

These schematics are PLDA GROUP property. They must be not reproduced or shared without PLDA GROUP written authorization. Copyright PLDA GROUP 2011. All rights reserved.

Designer:	Date:	Vérification:	Date:	Approval:	Date:
<b>PLDA GROUP</b> Parc Club du Golf Bâtiment 11 Rue Guillibert 13856 Aix-En-Provence Cedex 3 FRANCE Tel: +33 (0) 442 393 600 Fax: +33 (0) 442 394 902 www.pldagroup.com	Project Name		DESIGNATION		
	XpressK7		ALIM +MGTAVCC +MGTAVTT		
	Product Reference	Page	VERSION		
P130	7/30	DATE	AUTHOR	INDICE	
		19/03/2014	M.C.P.	V.2.2.9	

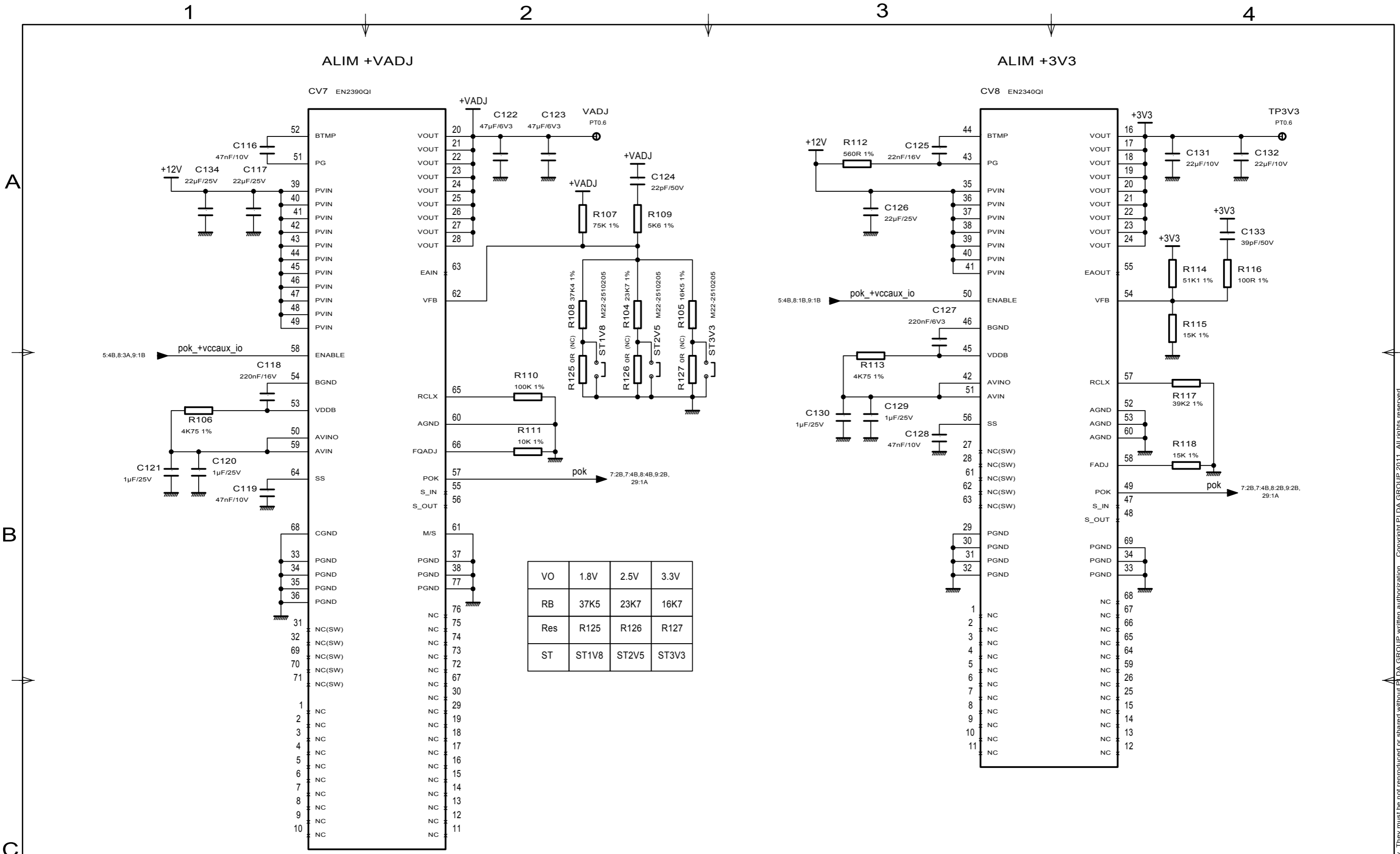

Designer:	Date:	Vérification:	Date:	Approval:	Date:
<b>PLDA GROUP</b> Parc Club du Golf Bâtiment 11 Rue Guillibert 13856 Aix-En-Provence Cedex 3 FRANCE Tel: +33 (0) 442 393 600 Fax: +33 (0) 442 394 902 www.pldagroup.com	Project Name		DESIGNATION		
	XpressK7		ALIM +VADJ +3V3		
	Product Reference	Page	VERSION		
P130	8/30	DATE	AUTHOR	INDICE	
		19/03/2014	MJC	V.2.2.0	

These schematics are PLDA GROUP property. They must be not reproduced or shared without PLDA GROUP written authorization. Copyright PLDA GROUP 2011. All rights reserved.



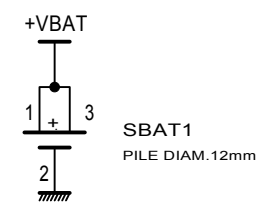
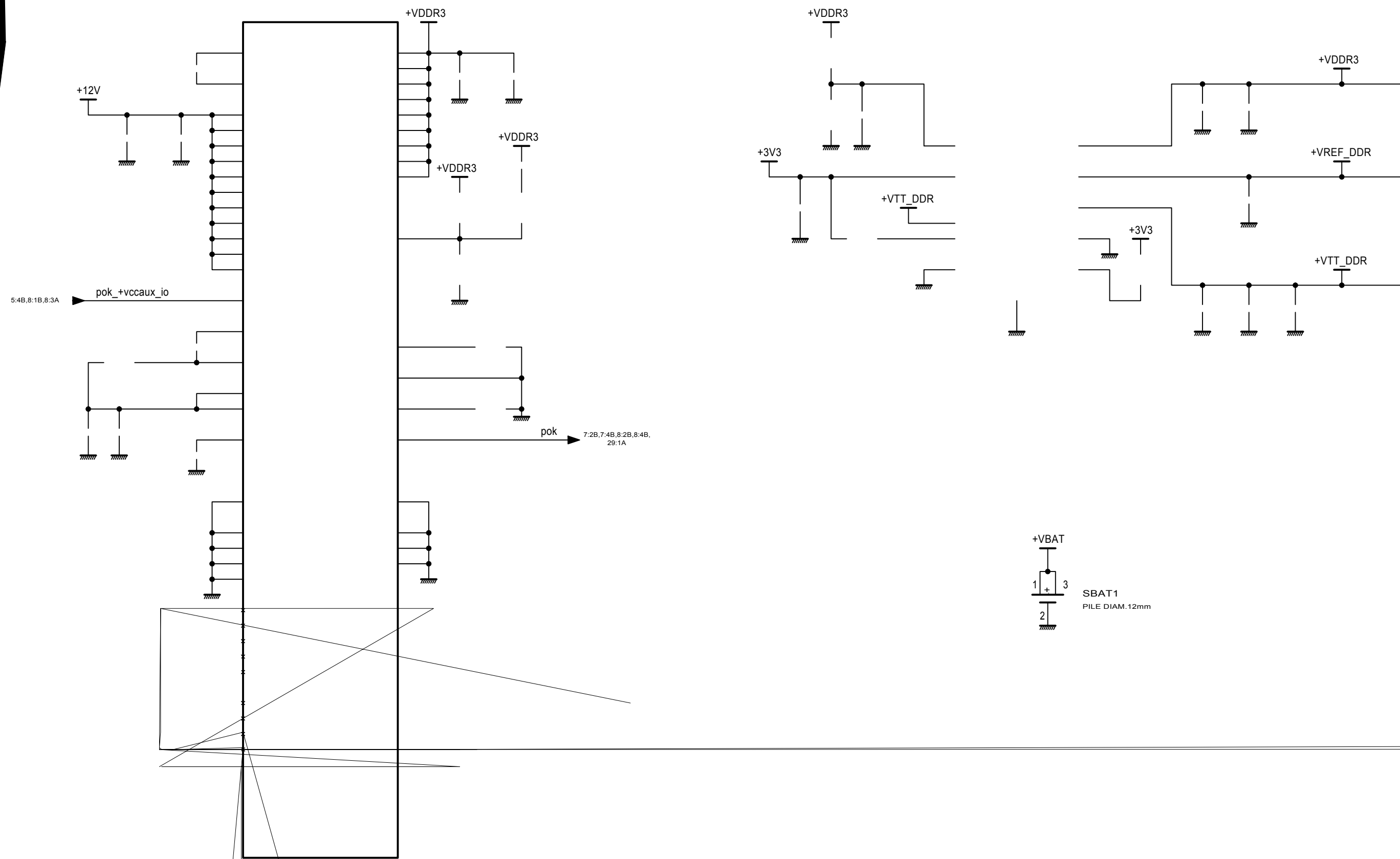

Designer:	Date:	Vérification:	Date:	Approval:	Date:	
<b>PLDA GROUP</b> Parc Club du Golf Bâtiment 11 Rue Guilibert 13856 Aix-En-Provence Cedex 3 FRANCE Tel: +33 (0) 442 393 600 Fax: +33 (0) 442 394 902 www.pldagroup.com		Project Name		DESIGNATION		
		Product Reference	Page	VERSION		
				DATE	AUTHOR	INDICE
					V	

These schematics are PLDA GROUP property. They must be not reproduced or shared without PLDA GROUP written authorization. Copyright PLDA GROUP 2011. All rights reserved

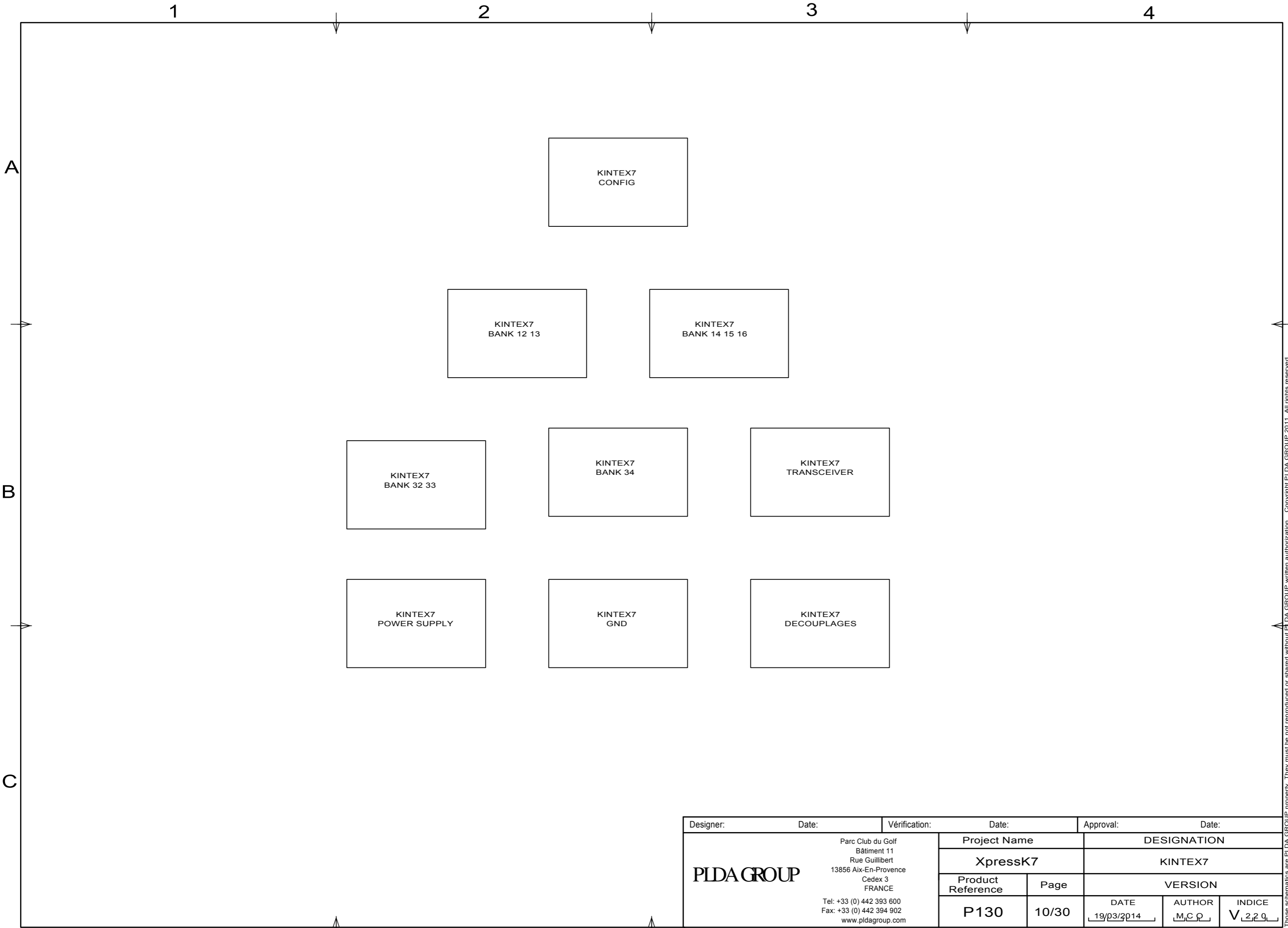

Designer:	Date:	Vérification:	Date:	Approval:	Date:
<b>PLDA GROUP</b> Parc Club du Golf Bâtiment 11 Rue Guillibert 13856 Aix-En-Provence Cedex 3 FRANCE Tel: +33 (0) 442 393 600 Fax: +33 (0) 442 394 902 www.pldagroup.com	Project Name		DESIGNATION		
	XpressK7		KINTEX7		
	Product Reference	Page	VERSION		
	P130	10/30	DATE	AUTHOR	INDICE
		19/03/2014	M.C.P.	V.2.2.0	

These schematics are PLDA GROUP property. They must be not reproduced or shared without PLDA GROUP written authorization. Copyright PLDA GROUP 2011. All rights reserved

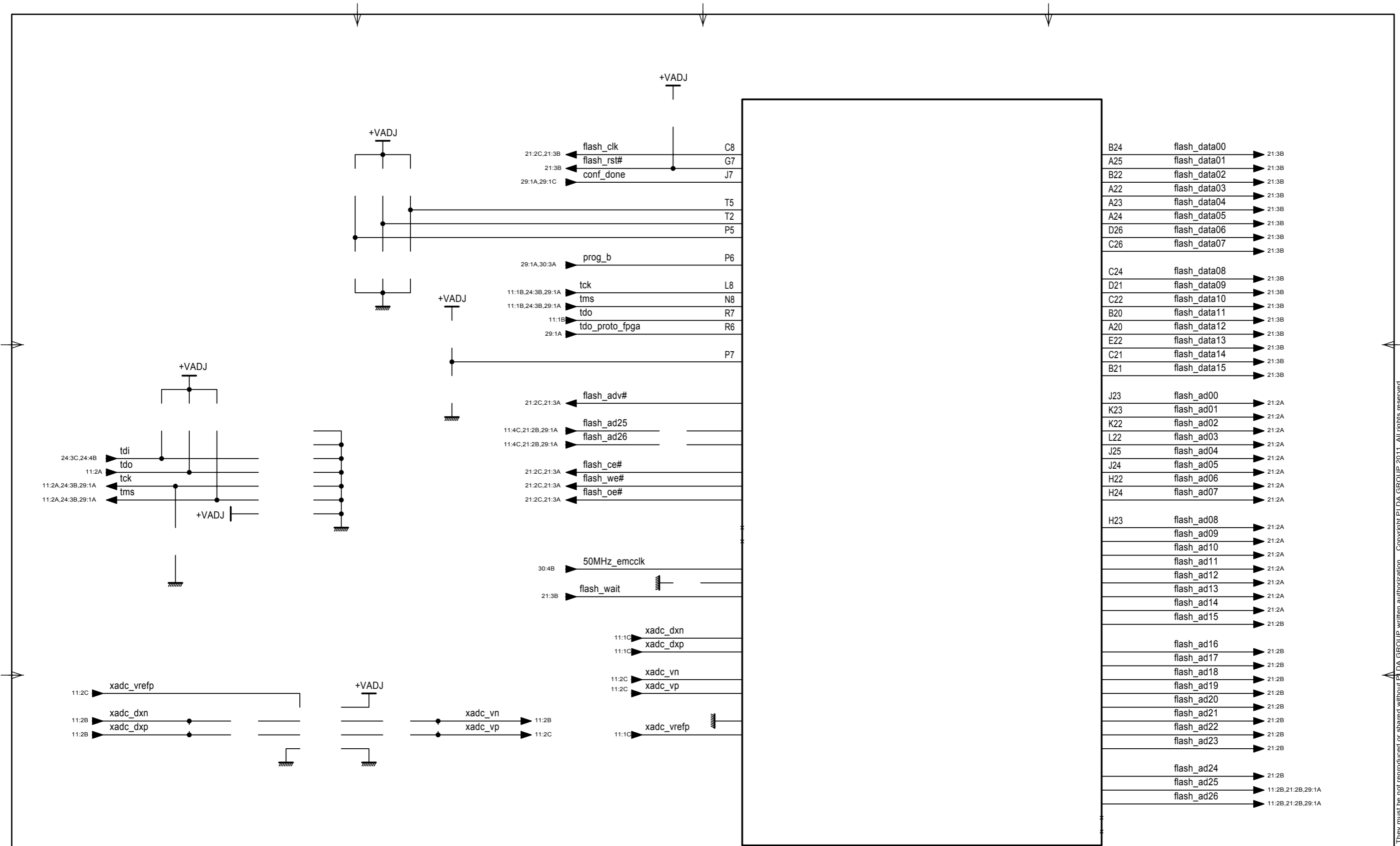

Designer:	Date:	Vérification:	Date:	Approval:	Date:
<b>PLDA GROUP</b> Parc Club du Golf Bâtiment 11 Rue Guilibert 13856 Aix-En-Provence Cedex 3 FRANCE Tel: +33 (0) 442 393 600 Fax: +33 (0) 442 394 902 www.pldagroup.com		Project Name		DESIGNATION	
		Product Reference	Page	VERSION	
		DATE	AUTHOR	INDICE	
		____	____	V____	

These schematics are PLDA GROUP property. They must not be reproduced or shared without PLDA GROUP written authorization. Copyright PLDA GROUP 2011. All rights reserved.

1

2

3

4

A

B

C

U1-B XC7K160T-2FBG676C

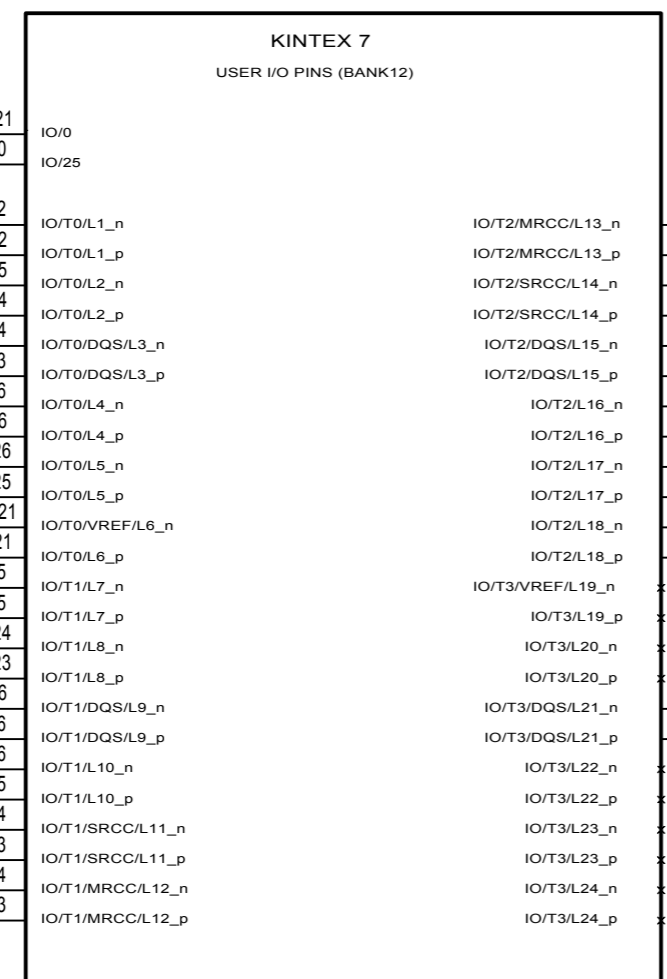

HR (1.2V à 3.3V)

U1-C XC7K160T-2FBG676C

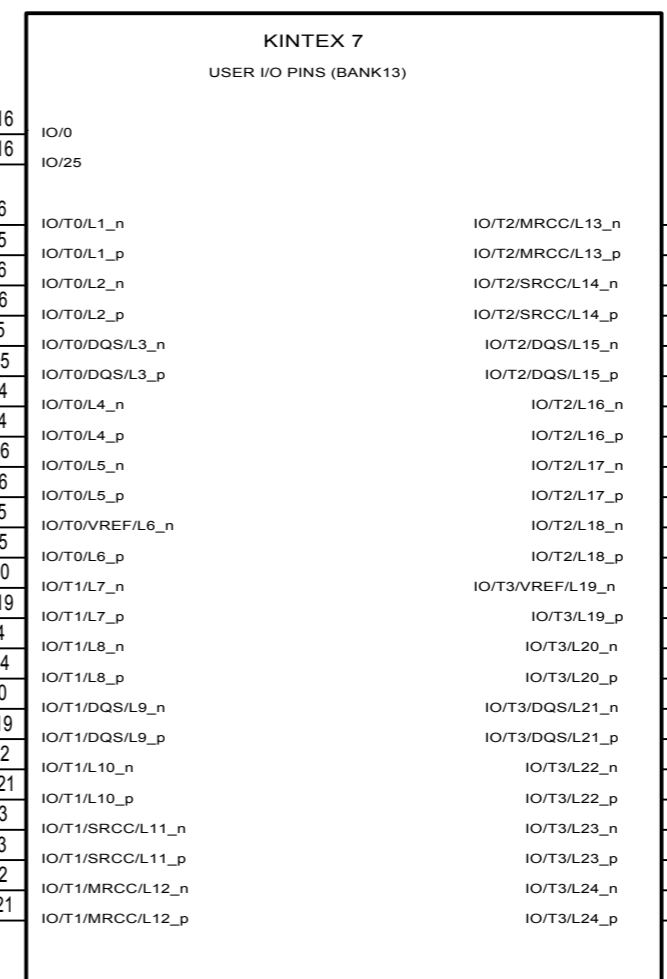

HR (1.2V à 3.3V)

Placement des signaux BANKS 12 13 14 15 16  
 Les horloges CLK0\_C2M et CLK0\_M2C CLK1\_C2M et CLK1\_M2C sont à placer sur des IO MRCC.  
 Les signaux avec une extension \_CC sont à placer sur des IO SRCC ou MRCC

Designer:	Date:	Vérification:	Date:	Approval:	Date:
<b>PLDA GROUP</b> Parc Club du Golf Bâtiment 11 Rue Guillibert 13856 Aix-En-Provence Cedex 3 FRANCE Tel: +33 (0) 442 393 600 Fax: +33 (0) 442 394 902 www.pldagroup.com	Project Name		DESIGNATION		
	XpressK7		KINTEX7 BANK 12 13		
	Product Reference	Page	VERSION		
	P130	12/30	DATE	AUTHOR	INDICE
		19/03/2014	M.C.P.	V.2.2.9	

These schematics are PLDA GROUP property. They must be not reproduced or shared without PLDA GROUP written authorization. Copyright PLDA GROUP 2011. All rights reserved

U1-D XC7K160T-2FBG676C

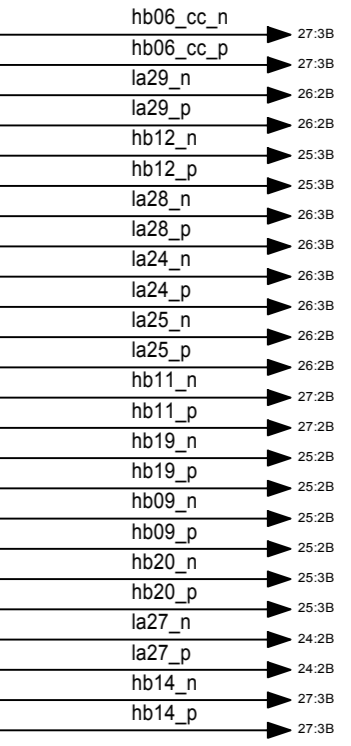
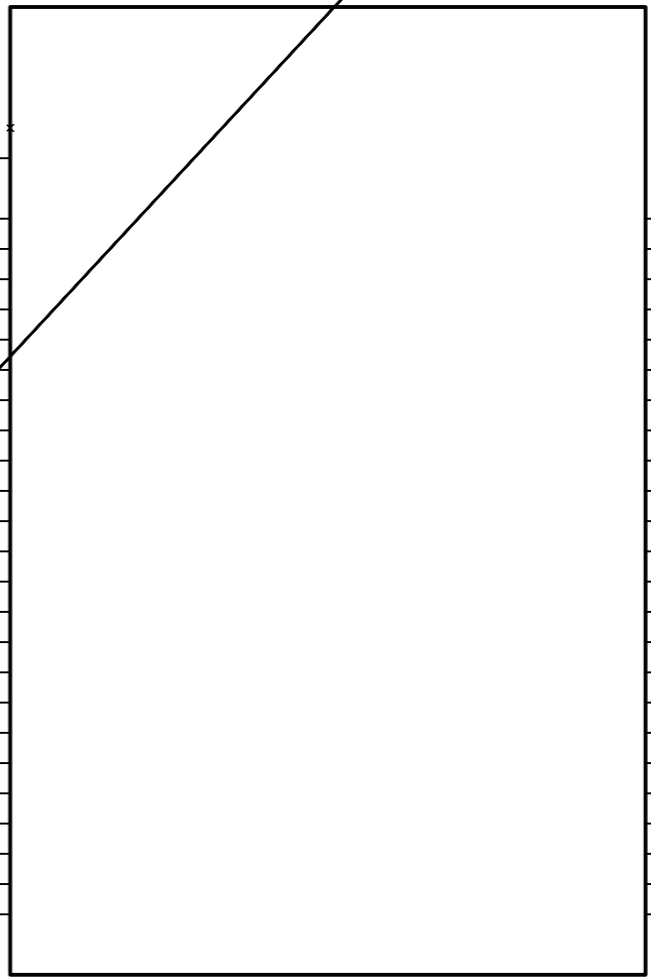
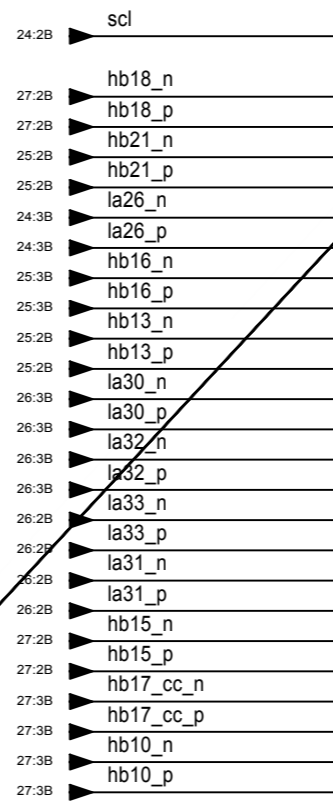
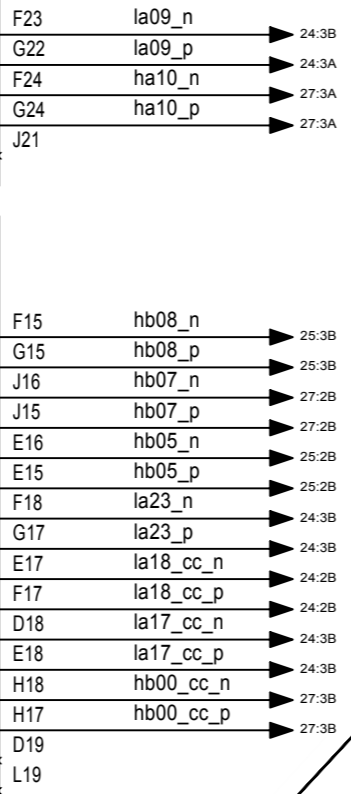
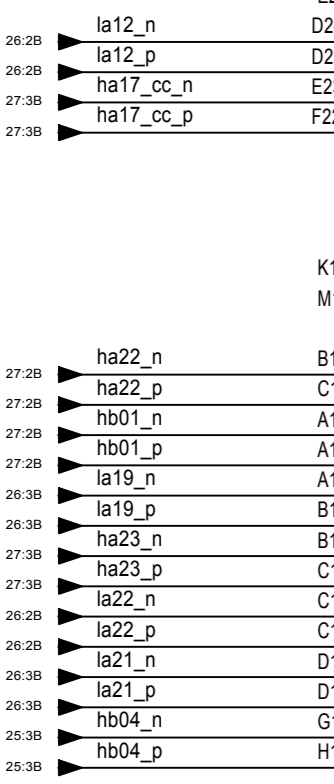
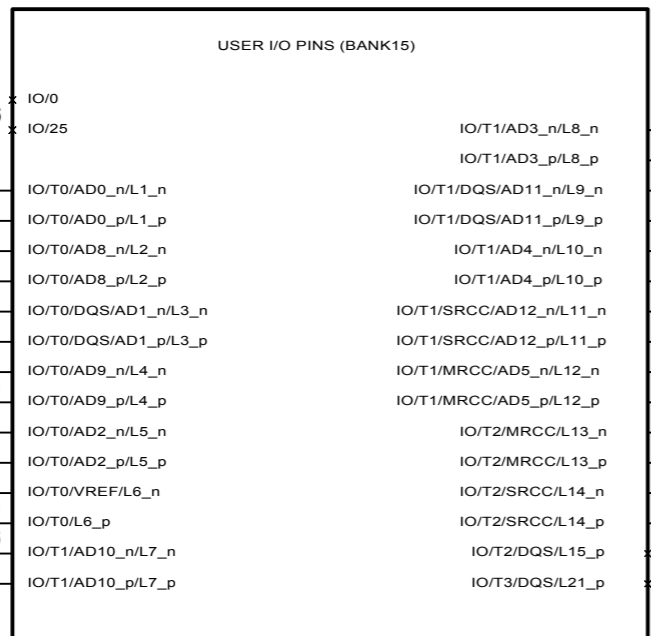
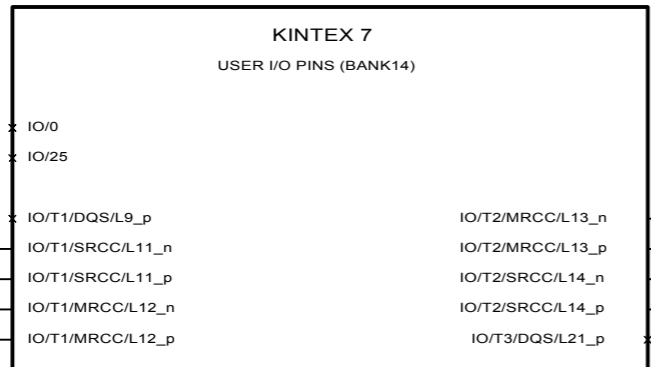

Designer:	Date:	Vérification:	Date:	Approval:	Date:
<b>PLDA GROUP</b> Parc Club du Golf Bâtiment 11 Rue Guillibert 13856 Aix-En-Provence Cedex 3 FRANCE Tel: +33 (0) 442 393 600 Fax: +33 (0) 442 394 902 www.pldagroup.com	Project Name		DESIGNATION		
	Product Reference	Page	VERSION		
			DATE	AUTHOR	INDICE

These schematics are PLDA GROUP property. They must be not reproduced or shared without PLDA GROUP written authorization. Copyright PLDA GROUP 2011. All rights reserved.

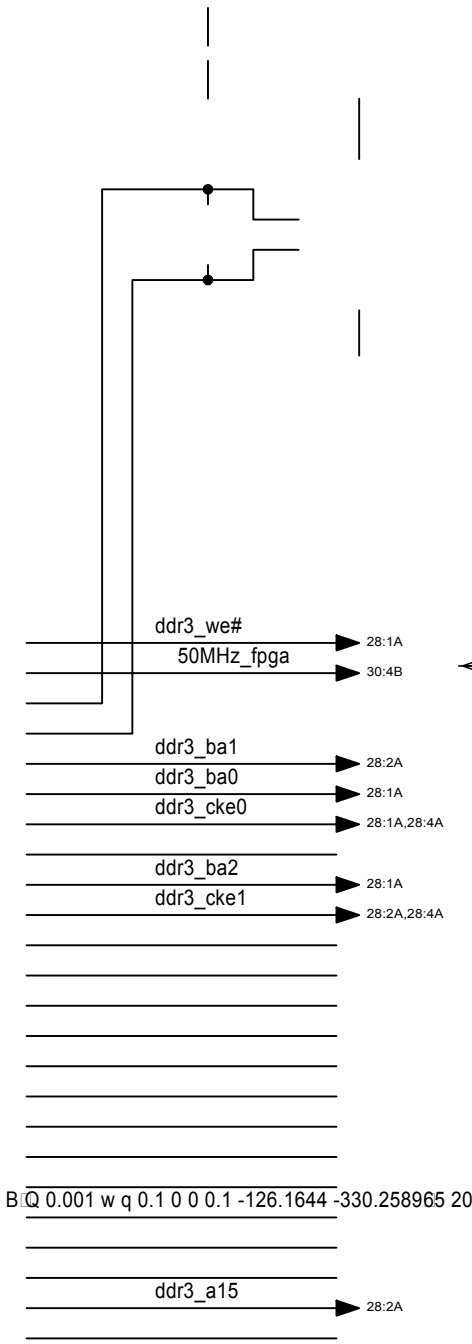
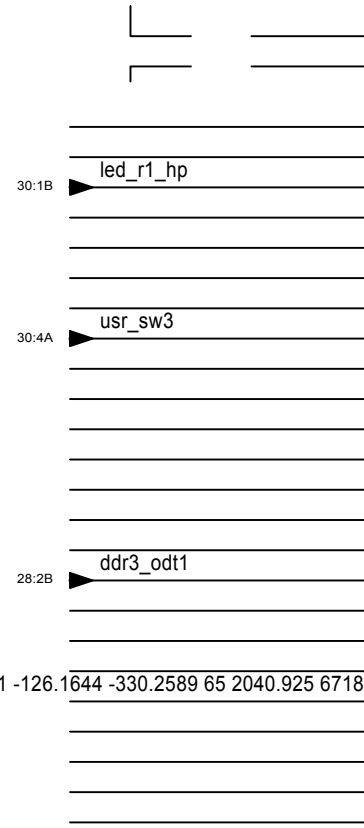
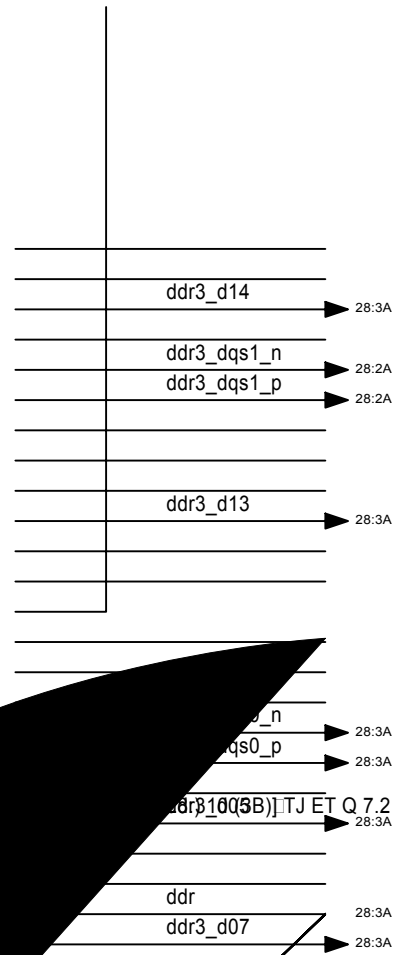
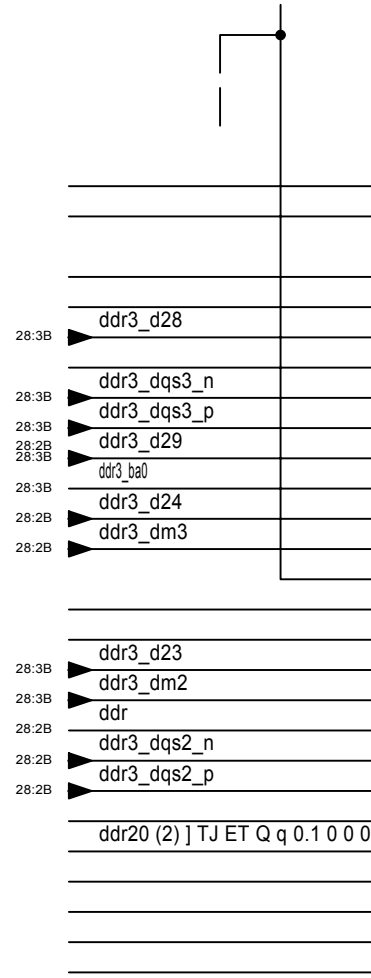

ddr20 (2) ] TJ ET Q q 0.1 0 0 0.1 -126.1644 -330.2589cm BT 0.02 Tc 50.5872 0... ddr3100(BB)] TJ ET Q 7.2 w q 0.1 0 0 0.1 -126.1644 -330.2589 65 2040.925 6718.0965 2040..108.547.4176l 2125.95612390 80365 2040. cm 6718.96 l B Q 0.001 w q 0.1 0 0 0.1 -126.1644 -330.258965 2040.9271.07 35-

Designer:	Date:	Vérification:	Date:	Approval:	Date:	
<b>PLDA GROUP</b> Parc Club du Golf Bâtiment 11 Rue Guilibert 13856 Aix-En-Provence Cedex 3 FRANCE Tel: +33 (0) 442 393 600 Fax: +33 (0) 442 394 902 www.pldagroup.com		Project Name		DESIGNATION		
		Product Reference	Page	VERSION		
				DATE	AUTHOR	INDICE

Those schematics are PLDA GROUP property. They must be not reproduced or shared without PLDA GROUP written authorization. Copyright PLDA GROUP 2011. All rights reserved.

1

2

3

4

A

B

C

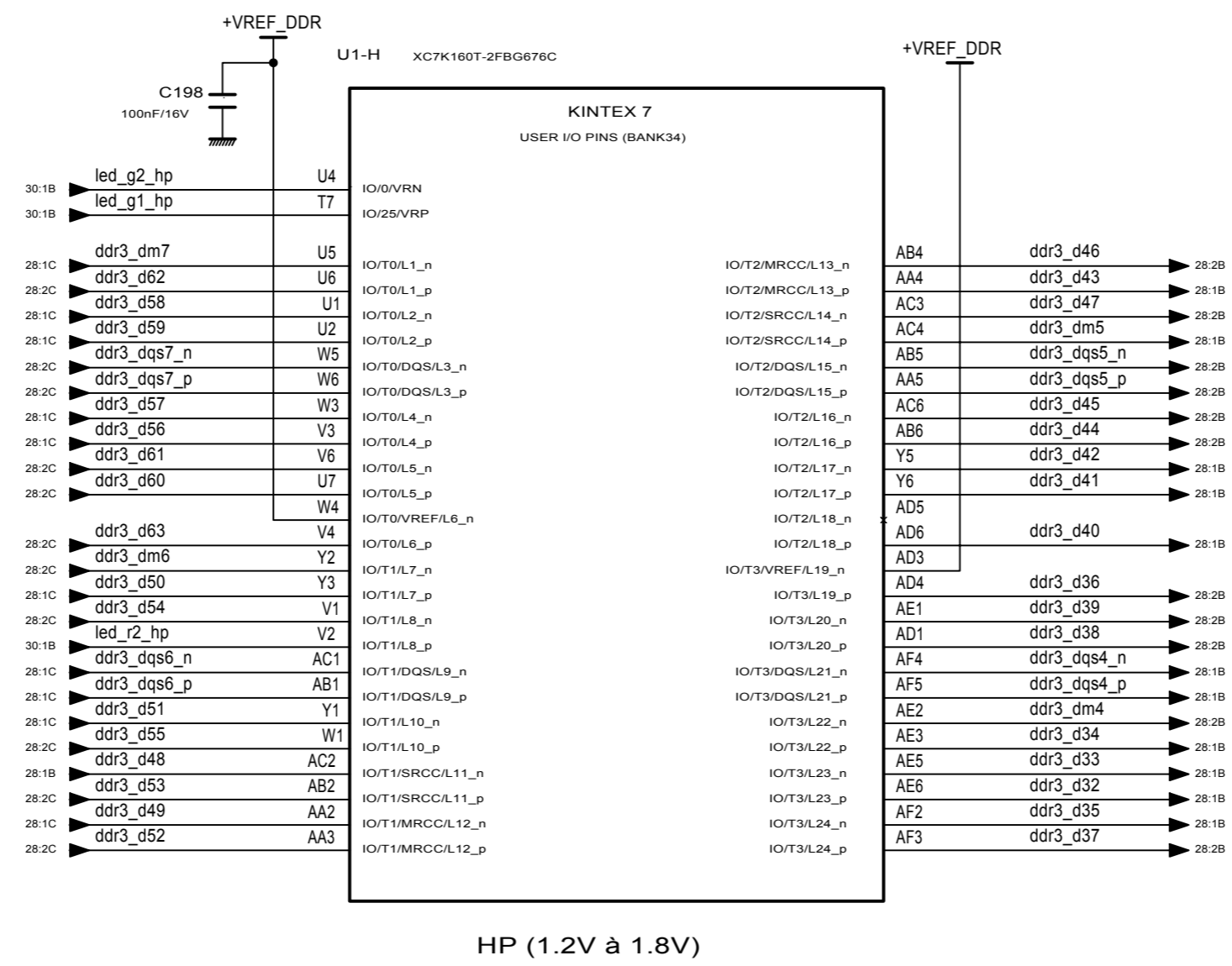

Designer:	Date:	Vérification:	Date:	Approval:	Date:
<b>PLDA GROUP</b> Parc Club du Golf Bâtiment 11 Rue Guillibert 13856 Aix-En-Provence Cedex 3 FRANCE Tel: +33 (0) 442 393 600 Fax: +33 (0) 442 394 902 www.pldagroup.com	Project Name		DESIGNATION		
	XpressK7		KINTEX7 BANK 34		
	Product Reference	Page	VERSION		
	P130	15/30	DATE	AUTHOR	INDICE
		19/03/2014	M.C.P.	V.2.2.9	

These schematics are PLDA GROUP property. They must be not reproduced or shared without PLDA GROUP written authorization. Copyright PLDA GROUP 2011. All rights reserved

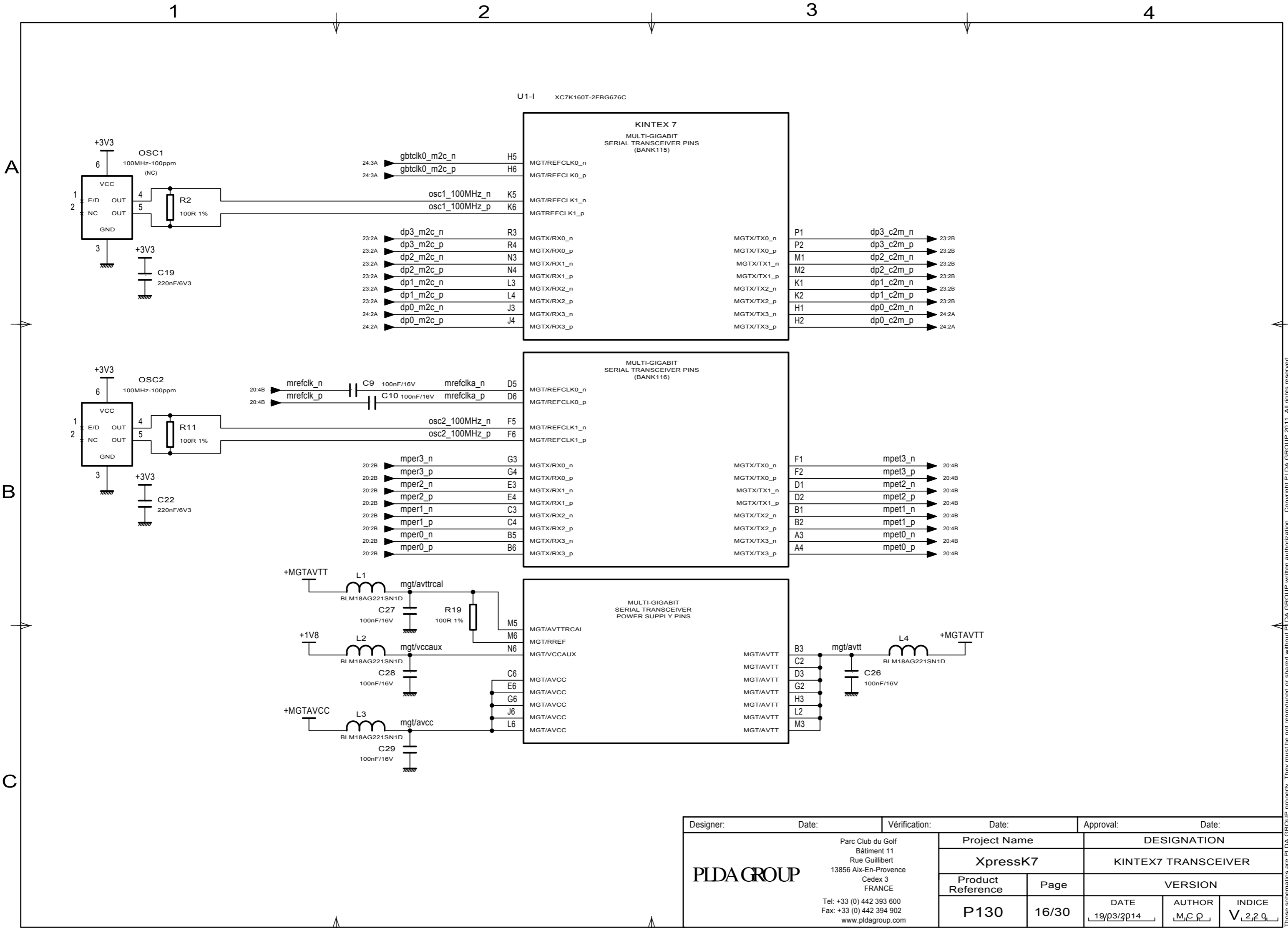

Designer:	Date:	Vérification:	Date:	Approval:	Date:
<b>PLDA GROUP</b> Parc Club du Golf Bâtiment 11 Rue Guillibert 13856 Aix-En-Provence Cedex 3 FRANCE Tel: +33 (0) 442 393 600 Fax: +33 (0) 442 394 902 www.pldagroup.com		Project Name		DESIGNATION	
		XpressK7		KINTEX7 TRANSCEIVER	
		Product Reference	Page	VERSION	
P130	16/30	DATE	AUTHOR	INDICE	
		19/03/2014	M.C.P.	V.2.2.9	

These schematics are PLDA GROUP property. They must be not reproduced or shared without PLDA GROUP written authorization. Copyright PLDA GROUP 2011. All rights reserved



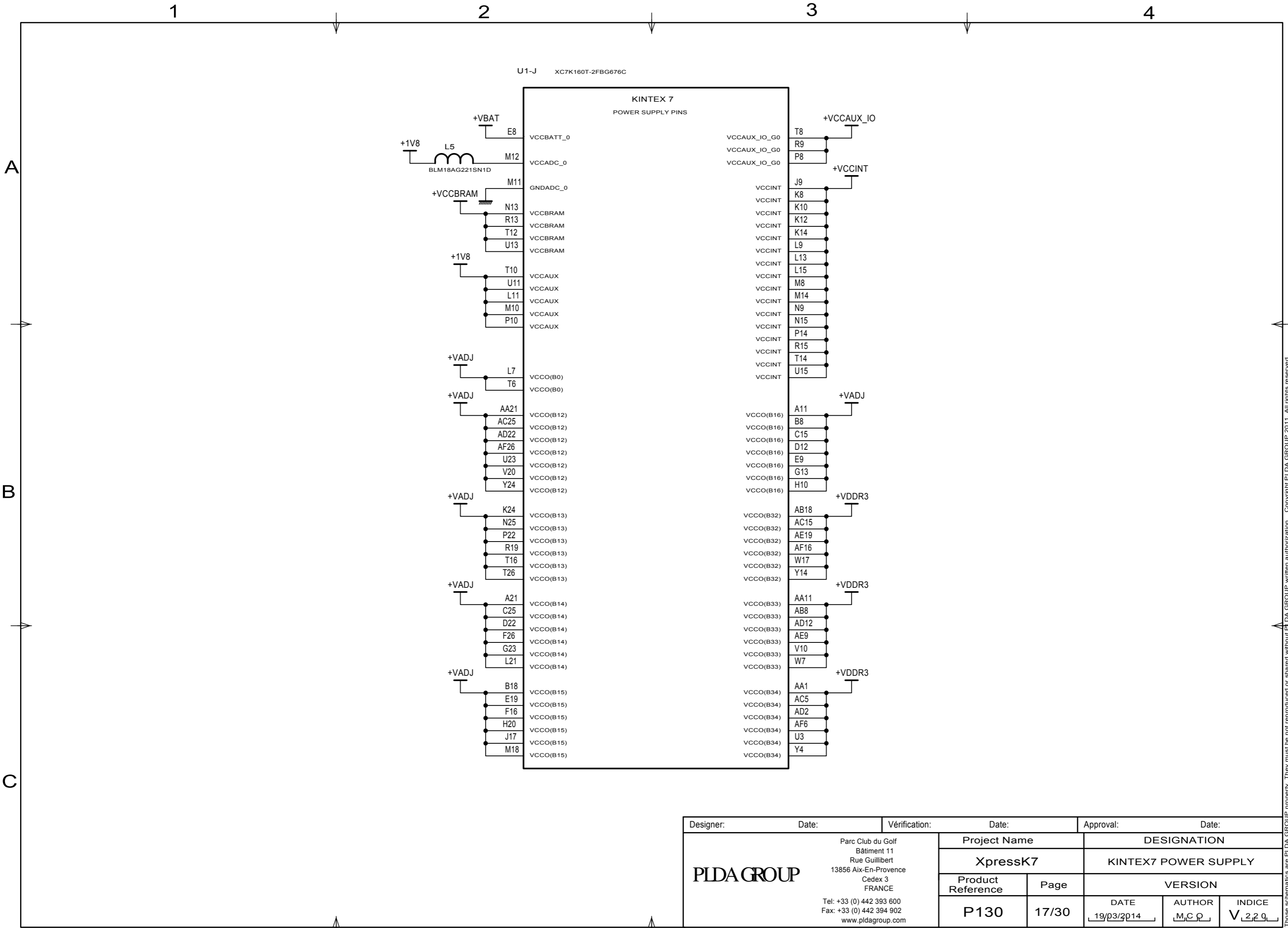

Designer:	Date:	Vérification:	Date:	Approval:	Date:
<b>PLDA GROUP</b> Parc Club du Golf Bâtiment 11 Rue Guilibert 13856 Aix-En-Provence Cedex 3 FRANCE Tel: +33 (0) 442 393 600 Fax: +33 (0) 442 394 902 www.pldagroup.com	Project Name		DESIGNATION		
	XpressK7		KINTEX7 POWER SUPPLY		
	Product Reference	Page	VERSION		
	P130	17/30	DATE	AUTHOR	INDICE
		19/03/2014	M.C.P.	V.2.2.9	

These schematics are PLDA GROUP property. They must be not reproduced or shared without PLDA GROUP written authorization. Copyright PLDA GROUP 2011. All rights reserved

1

2

3

4

A

B

C

U1-K XC7K160T-2FBG676C

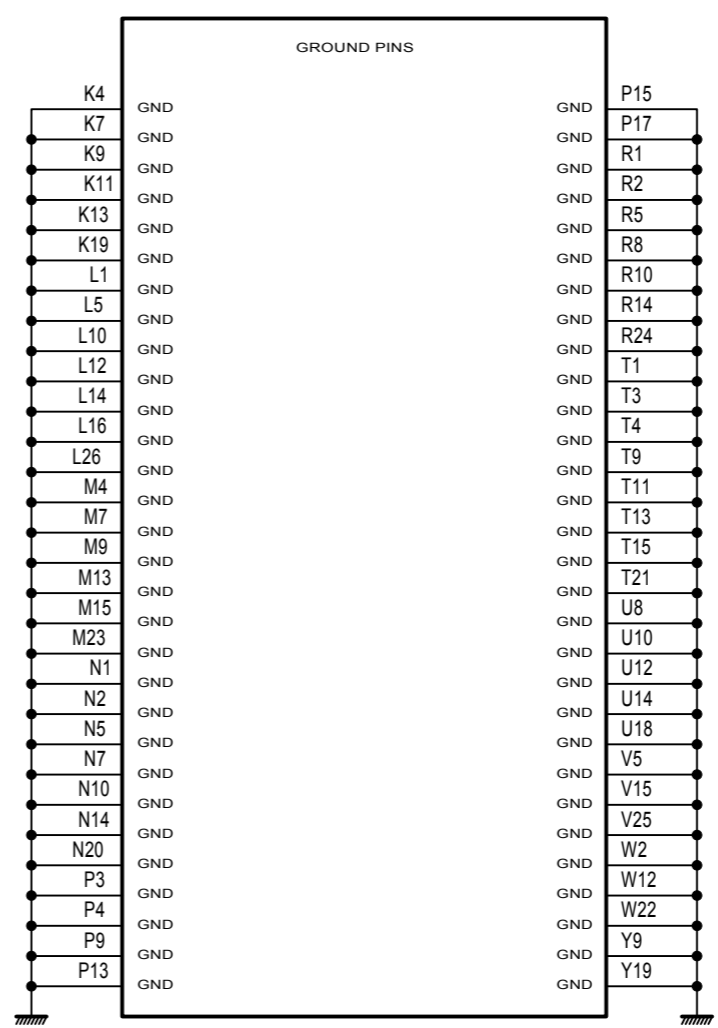
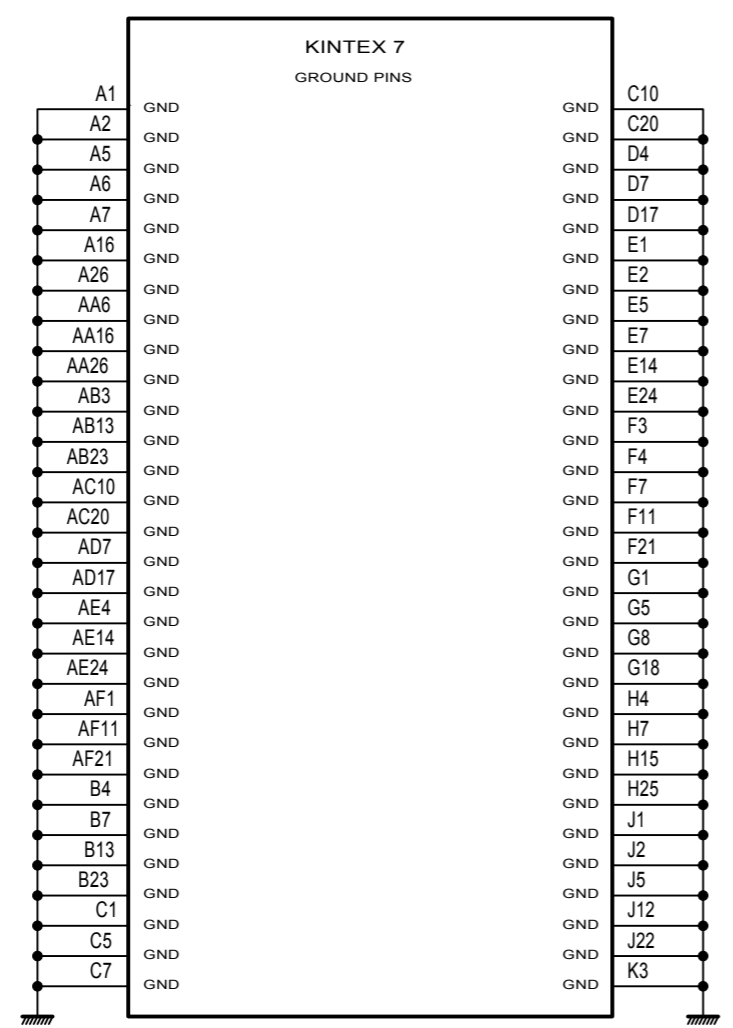

Designer:	Date:	Vérification:	Date:	Approval:	Date:
<b>PLDA GROUP</b> Parc Club du Golf Bâtiment 11 Rue Guillibert 13856 Aix-En-Provence Cedex 3 FRANCE Tel: +33 (0) 442 393 600 Fax: +33 (0) 442 394 902 www.pldagroup.com	Project Name		DESIGNATION		
	XpressK7		KINTEX7 GND		
	Product Reference	Page	VERSION		
	P130	18/30	DATE	AUTHOR	INDICE
		19/03/2014	M.C.P.	V.2.2.0	

These schematics are PLDA GROUP property. They must be not reproduced or shared without PLDA GROUP written authorization. Copyright PLDA GROUP 2011. All rights reserved

1

2

3

4

ALIM +VCCINT

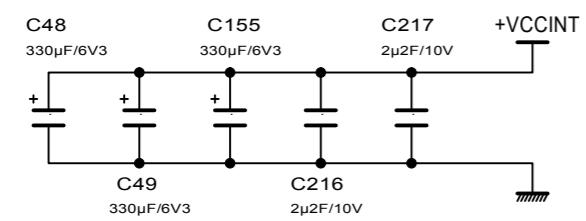

ALIM VADJ (BANK 0 +2V5 VCCO)

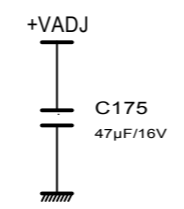

ALIM VADJ (BANKS 12 13 14 15 16 VCCO)

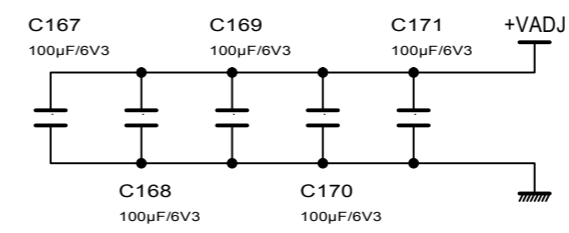

ALIM +VCCBRAM

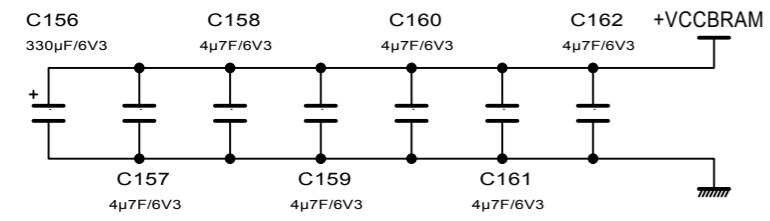

ALIM VDDR3 (BANKS 32 33 34 +1V5 VCCO)

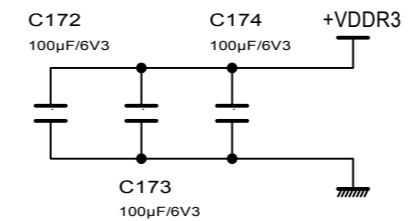

ALIM +1V8 (VCCAUX)

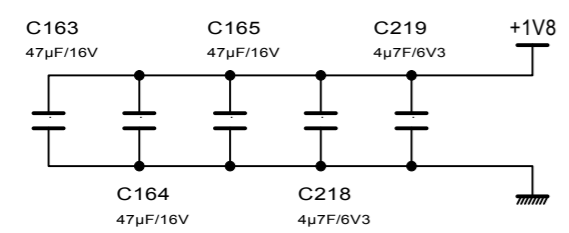

ALIM +1V8 (VCCAUX)

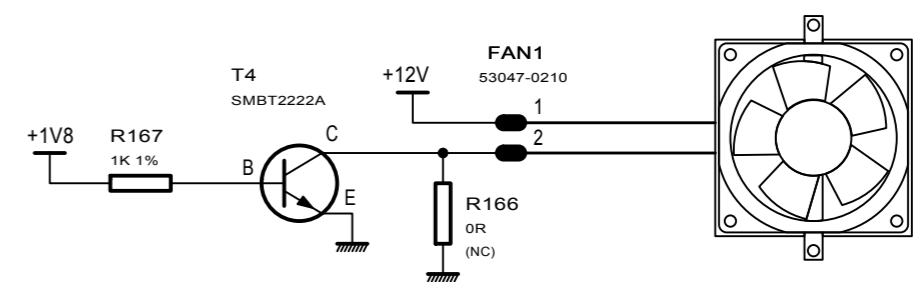
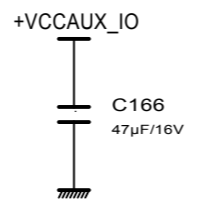

ALIM MGTAVTT

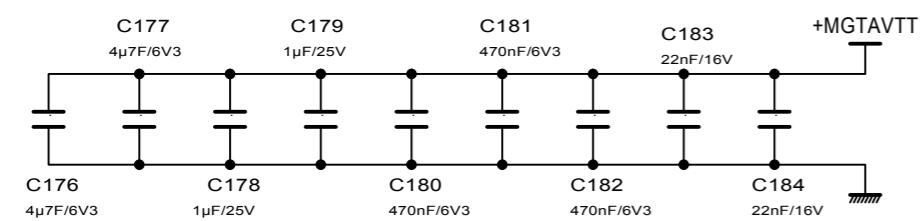

ALIM MGTAVCC

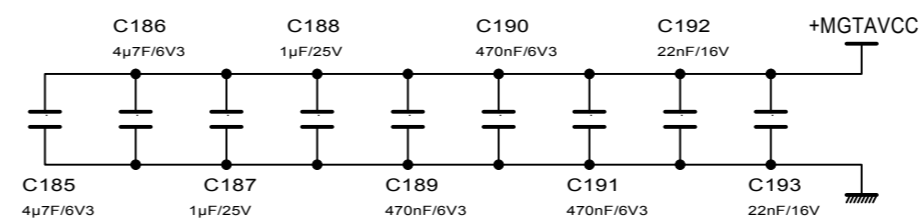

ALIM +1V8 (MGTVCCAUX)

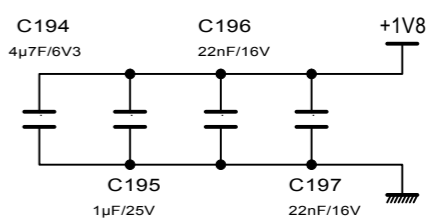

FIXATIONS VENTILATEUR



Designer:	Date:	Vérification:	Date:	Approval:	Date:	
<b>PLDA GROUP</b> Parc Club du Golf Bâtiment 11 Rue Guilibert 13856 Aix-En-Provence Cedex 3 FRANCE Tel: +33 (0) 442 393 600 Fax: +33 (0) 442 394 902 www.pldagroup.com		Project Name		DESIGNATION		
		XpressK7		KINTEX7 DECOUPLAGES		
		Product Reference	Page	VERSION		
		P130	19/30	DATE	AUTHOR	INDICE
		19/03/2014	MJC	V.2.2.9		

These schematics are PLDA GROUP property. They must be not reproduced or shared without PLDA GROUP written authorization. Copyright PLDA GROUP 2011. All rights reserved

1

2

3

4

### CONNECTEUR PCIe x4

(TOP SIDE)

**JB** (NC)  
PCI-EXPRESS-32FC

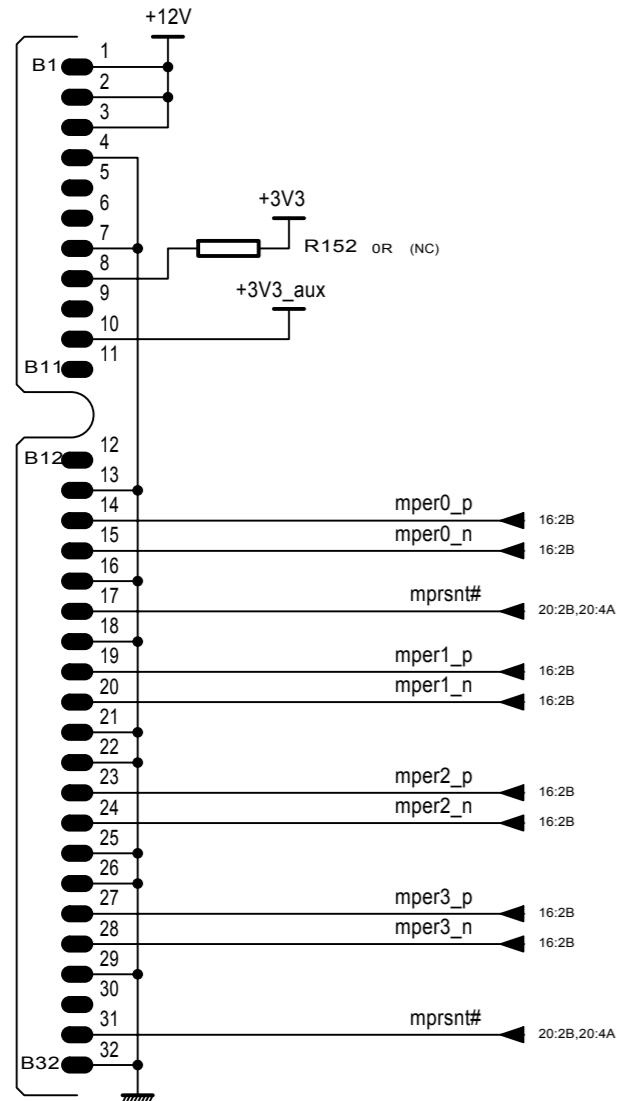

(BOTTOM SIDE)

**JA** (NC)  
PCI-EXPRESS-32FS

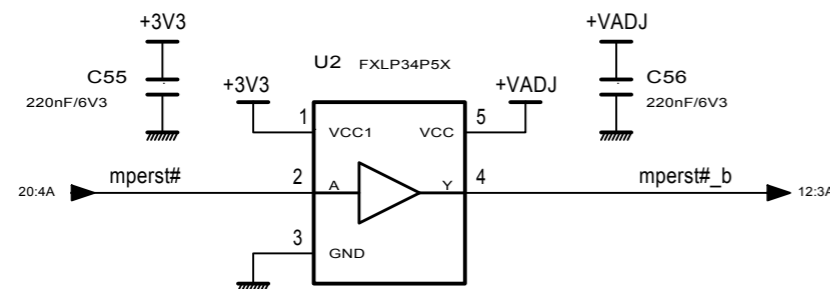
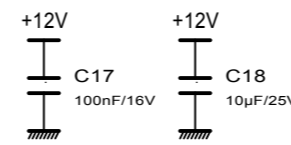
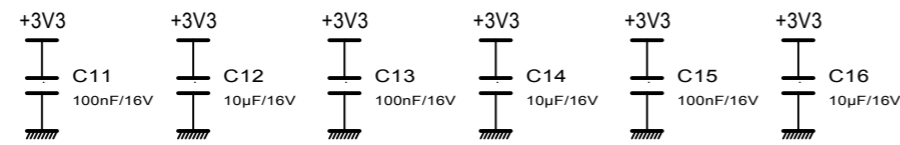
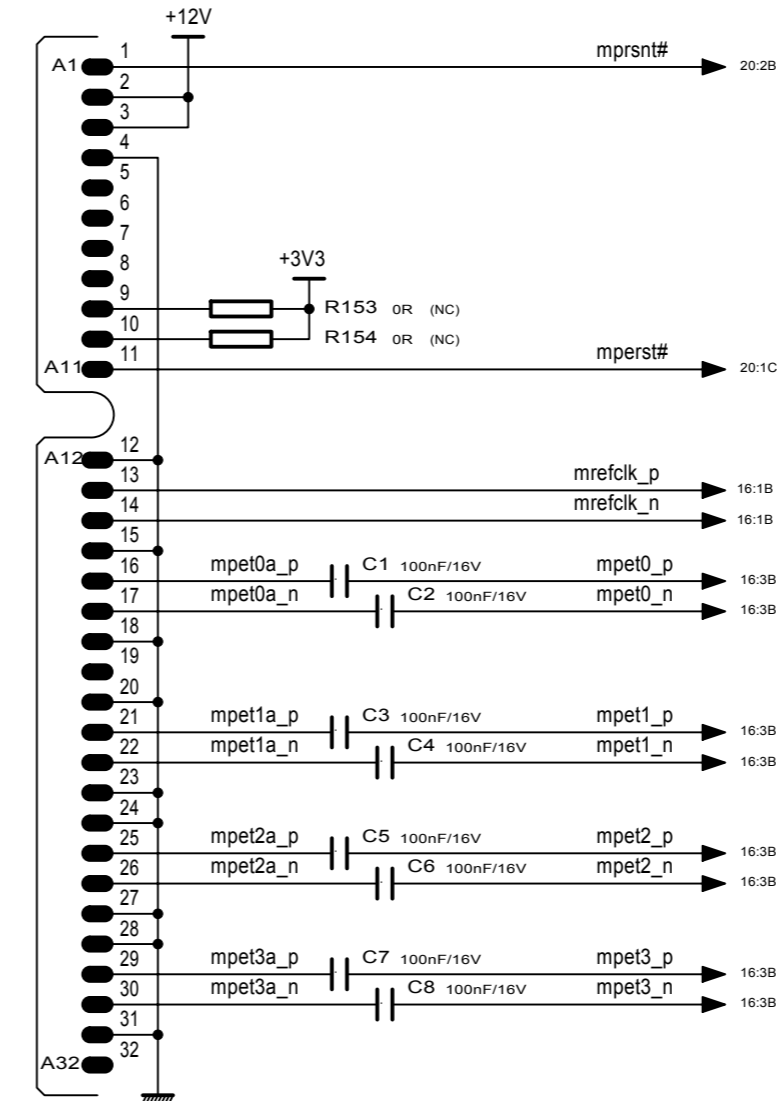

Designer:	Date:	Vérification:	Date:	Approval:	Date:
<b>PLDA GROUP</b>	Parc Club du Golf Bâtiment 11 Rue Guillibert 13856 Aix-En-Provence Cedex 3 FRANCE		Project Name		DESIGNATION
	Tel: +33 (0) 442 393 600 Fax: +33 (0) 442 394 902 www.pldagroup.com		XpressK7		PCI EXPRESS
	Product Reference	Page	VERSION		
P130	20/30	DATE	AUTHOR	INDICE	
		19/03/2014	M.C.P.	V.2.2.9	

These schematics are PLDA GROUP property. They must be not reproduced or shared without PLDA GROUP written authorization. Copyright PLDA GROUP 2011. All rights reserved.

1

2

3

4

A

B

C

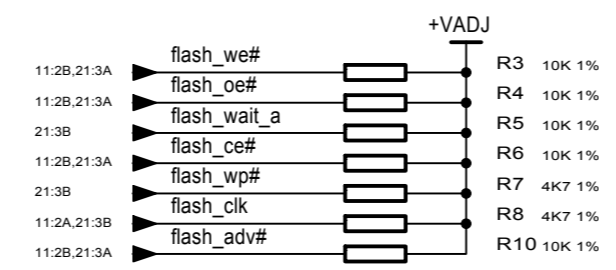
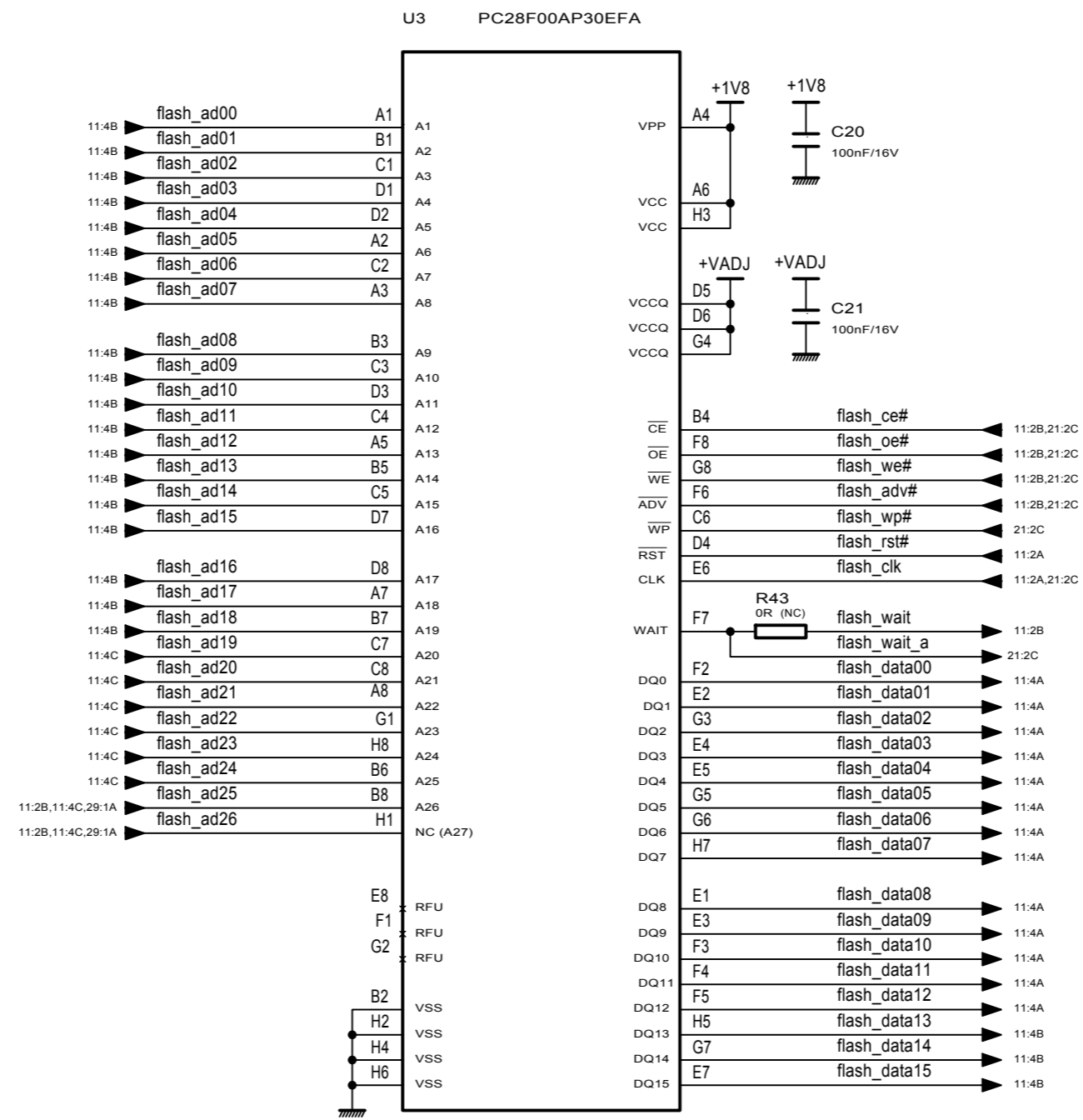

Designer:	Date:	Vérification:	Date:	Approval:	Date:
<b>PLDA GROUP</b> Parc Club du Golf Bâtiment 11 Rue Guilibert 13856 Aix-En-Provence Cedex 3 FRANCE Tel: +33 (0) 442 393 600 Fax: +33 (0) 442 394 902 www.pldagroup.com		Project Name		DESIGNATION	
		XpressK7		FLASHPROM BPI	
		Product Reference	Page	VERSION	
P130	21/30	DATE	AUTHOR	INDICE	
		19/03/2014	M.C.P.	V.2.2.9	

These schematics are PLDA GROUP property. They must be not reproduced or shared without PLDA GROUP written authorization. Copyright PLDA GROUP 2011. All rights reserved

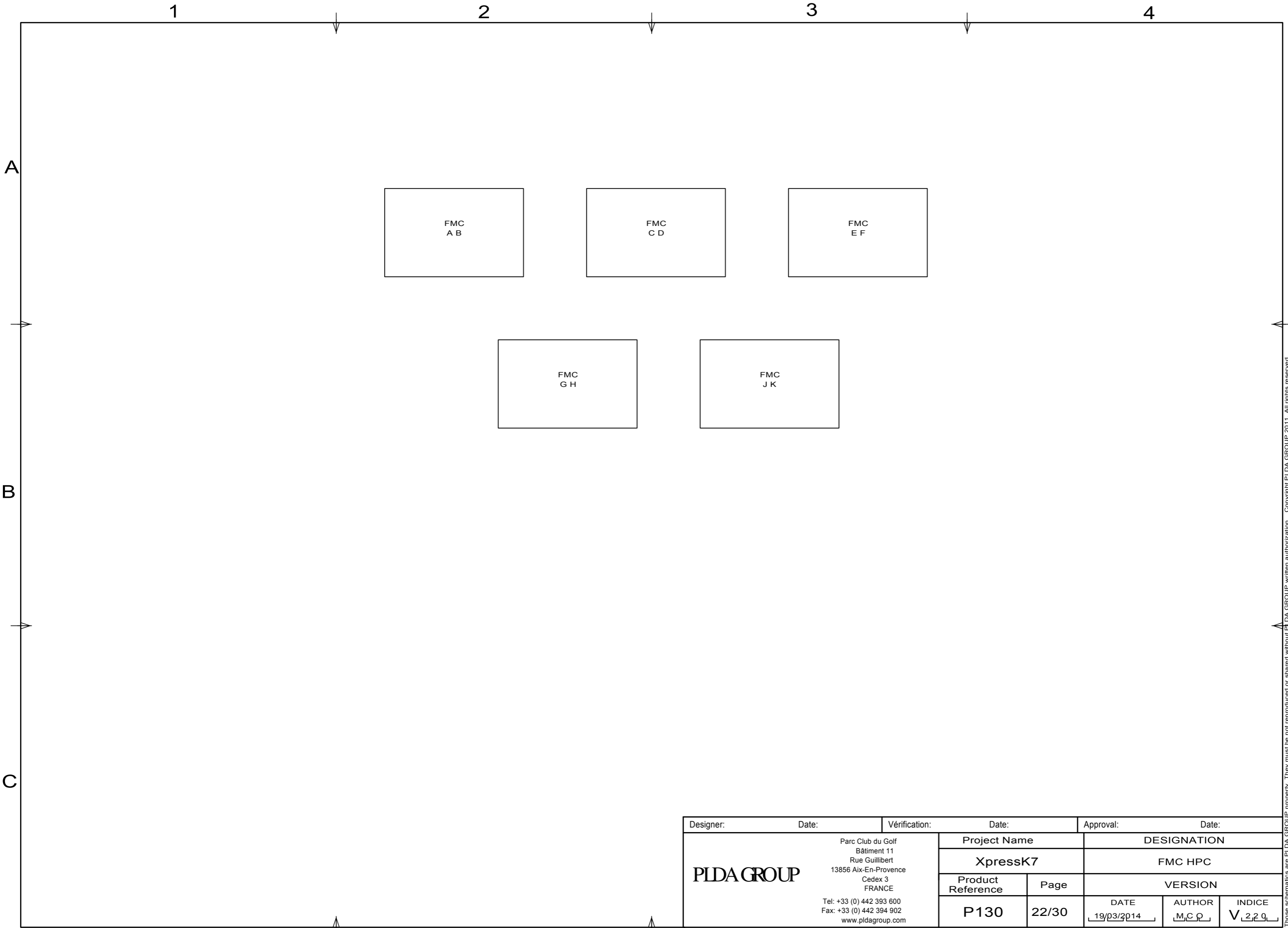

Designer:	Date:	Vérification:	Date:	Approval:	Date:
<b>PLDA GROUP</b> Parc Club du Golf Bâtiment 11 Rue Guilibert 13856 Aix-En-Provence Cedex 3 FRANCE Tel: +33 (0) 442 393 600 Fax: +33 (0) 442 394 902 www.pldagroup.com	Project Name		DESIGNATION		
	XpressK7		FMC HPC		
	Product Reference	Page	VERSION		
	P130	22/30	DATE	AUTHOR	INDICE
		19/03/2014	M.C.P.	V.2.2.9	

These schematics are PLDA GROUP property. They must be not reproduced or shared without PLDA GROUP written authorization. Copyright PLDA GROUP 2011. All rights reserved

1

2

3

4

A

B

C

**FMC**  
ASP-134486-01

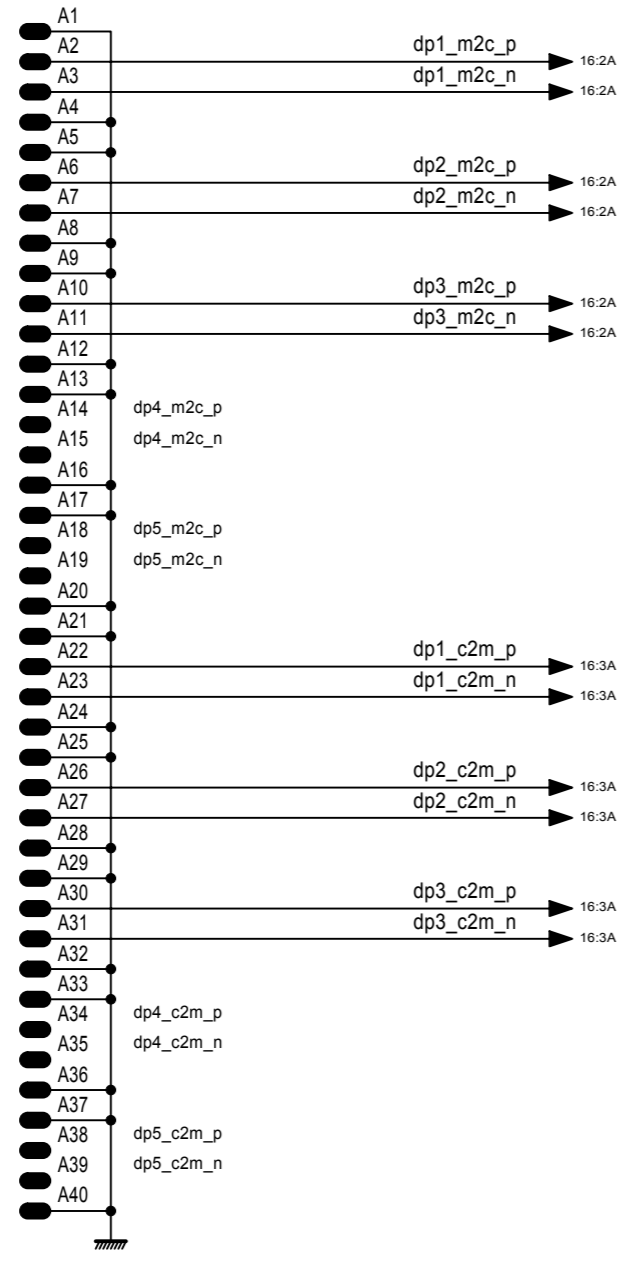

**FMC**

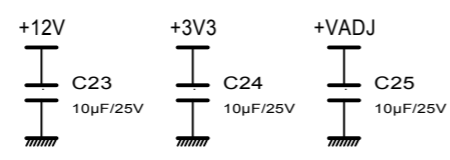
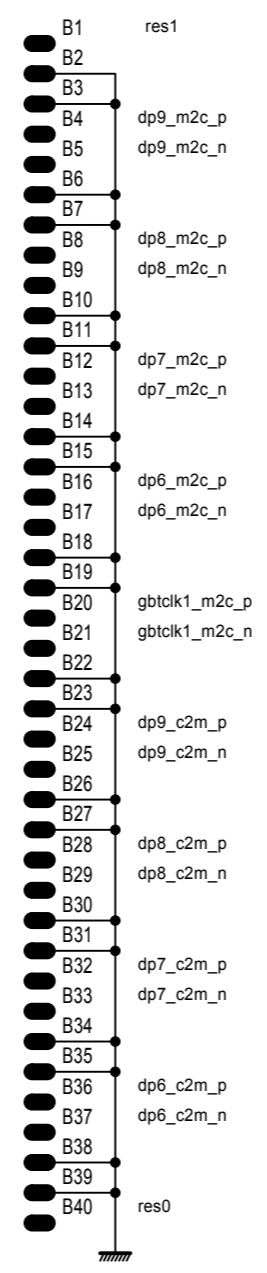

**FIXATIONS MEZZANINE**

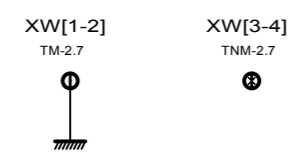

Designer:	Date:	Vérification:	Date:	Approval:	Date:
<b>PLDA GROUP</b>	Parc Club du Golf Bâtiment 11 Rue Guillibert 13856 Aix-En-Provence Cedex 3 FRANCE		Project Name		DESIGNATION
	Tel: +33 (0) 442 393 600 Fax: +33 (0) 442 394 902 www.pldagroup.com		XpressK7		FMC A B
	Product Reference	Page	VERSION		
	P130	23/30	DATE	AUTHOR	INDICE
		19/03/2014	M.C.P.	V.2.2.9	

These schematics are PLDA GROUP property. They must be not reproduced or shared without PLDA GROUP written authorization. Copyright PLDA GROUP 2011. All rights reserved.

1

2

3

4

A

B

C

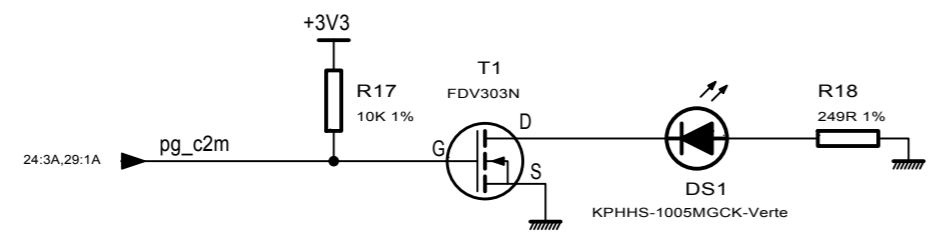
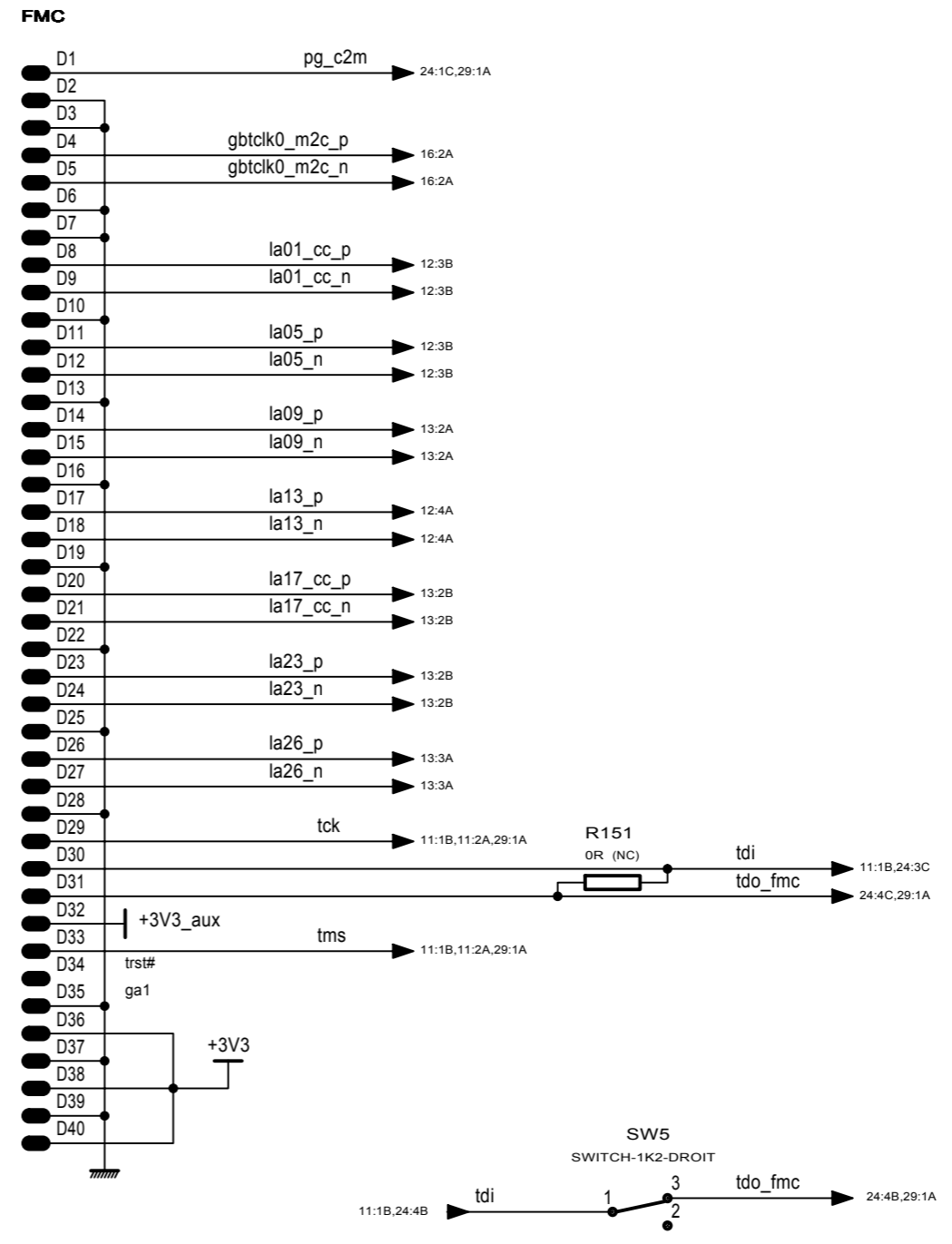
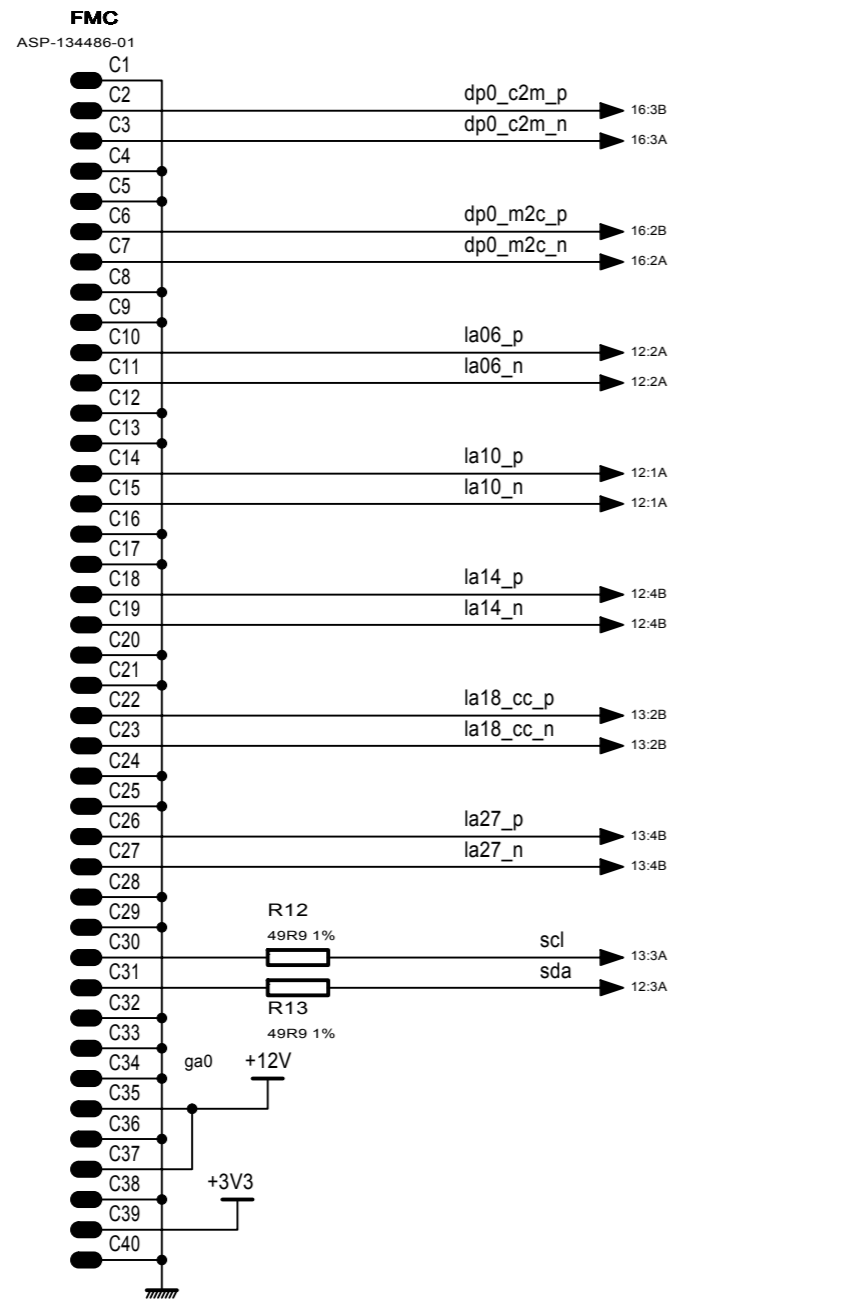

Designer:	Date:	Vérification:	Date:	Approval:	Date:
<b>PLDA GROUP</b> Parc Club du Golf Bâtiment 11 Rue Guillibert 13856 Aix-En-Provence Cedex 3 FRANCE Tel: +33 (0) 442 393 600 Fax: +33 (0) 442 394 902 www.pldagroup.com	Project Name		DESIGNATION		
	XpressK7		FMC C D		
	Product Reference	Page	VERSION		
P130	24/30	DATE	AUTHOR	INDICE	
		19/03/2014	M.C.P.	V.2.2.9	

These schematics are PLDA GROUP property. They must be not reproduced or shared without PLDA GROUP written authorization. Copyright PLDA GROUP 2011. All rights reserved.



1

2

3

4

A

B

C

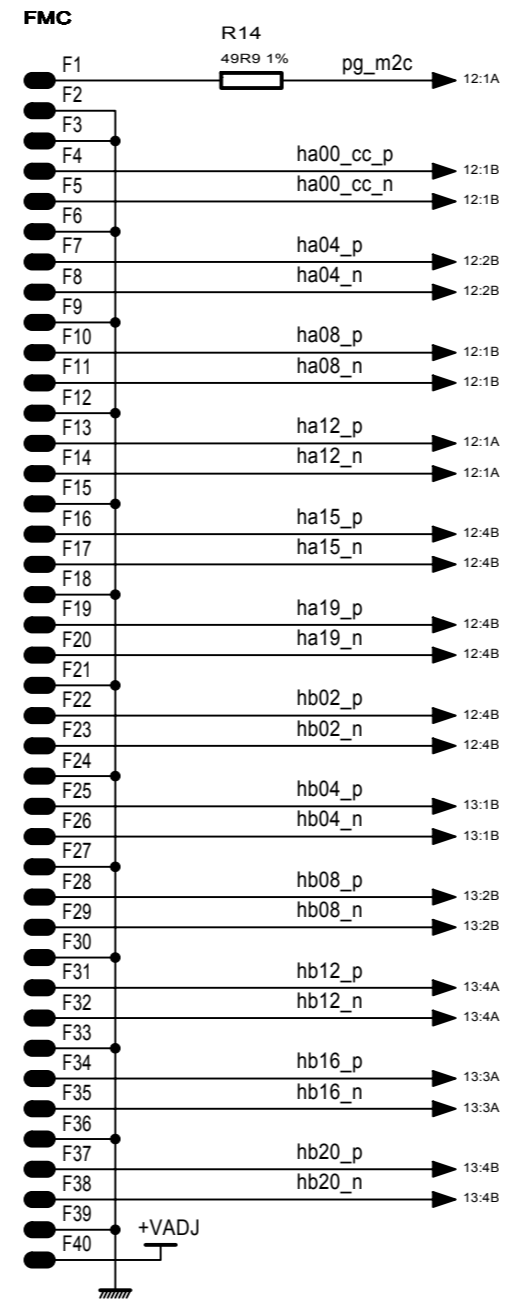
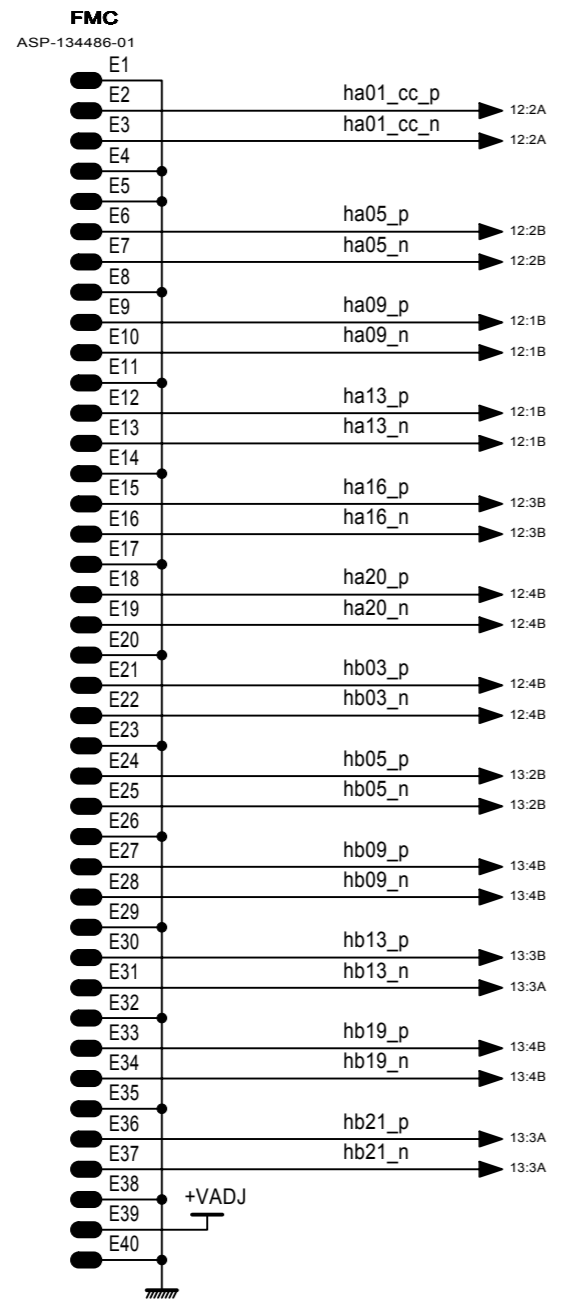

Designer:	Date:	Vérification:	Date:	Approval:	Date:
<b>PLDA GROUP</b> Parc Club du Golf Bâtiment 11 Rue Guillibert 13856 Aix-En-Provence Cedex 3 FRANCE Tel: +33 (0) 442 393 600 Fax: +33 (0) 442 394 902 www.pldagroup.com	Project Name		DESIGNATION		
	XpressK7		FMC E F		
	Product Reference	Page	VERSION		
	P130	25/30	DATE	AUTHOR	INDICE
		19/03/2014	M.C.P.	V.2.2.9	

These schematics are PLDA GROUP property. They must be not reproduced or shared without PLDA GROUP written authorization. Copyright PLDA GROUP 2011. All rights reserved

1

2

3

4

A

B

C

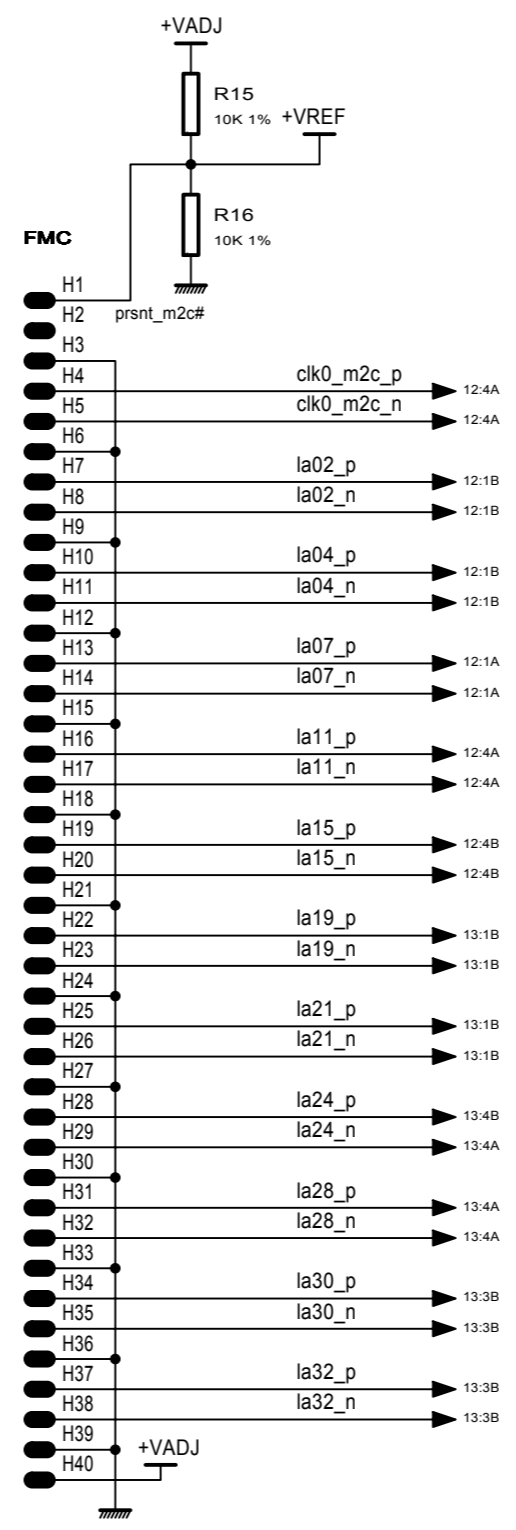
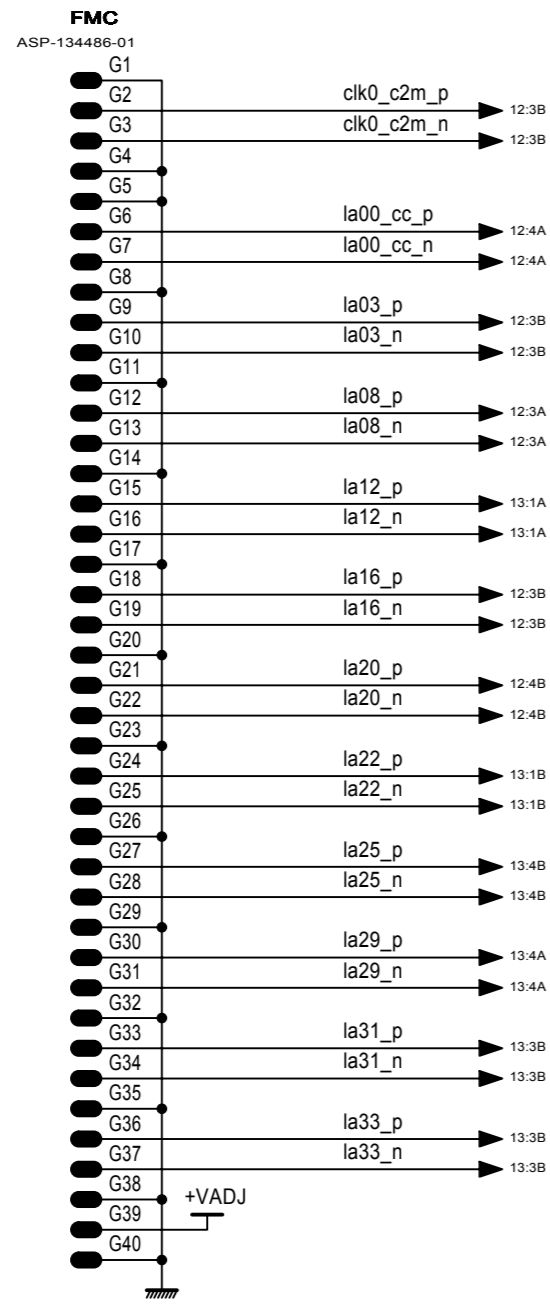

Designer:	Date:	Vérification:	Date:	Approval:	Date:
<b>PLDA GROUP</b> Parc Club du Golf Bâtiment 11 Rue Guillibert 13856 Aix-En-Provence Cedex 3 FRANCE Tel: +33 (0) 442 393 600 Fax: +33 (0) 442 394 902 www.pldagroup.com	Project Name		DESIGNATION		
	XpressK7		FMC G H		
	Product Reference	Page	VERSION		
	P130	26/30	DATE	AUTHOR	INDICE
		19/03/2014	M.C.P.	V.2.2.0	

These schematics are PLDA GROUP property. They must be not reproduced or shared without PLDA GROUP written authorization. Copyright PLDA GROUP 2011. All rights reserved

1

2

3

4

A

B

C

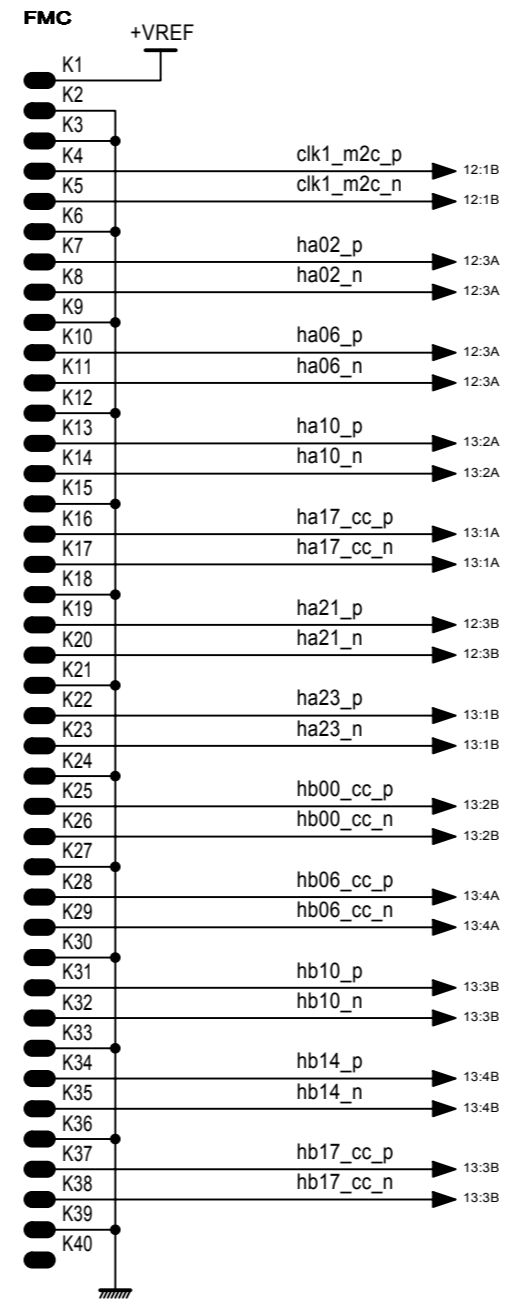
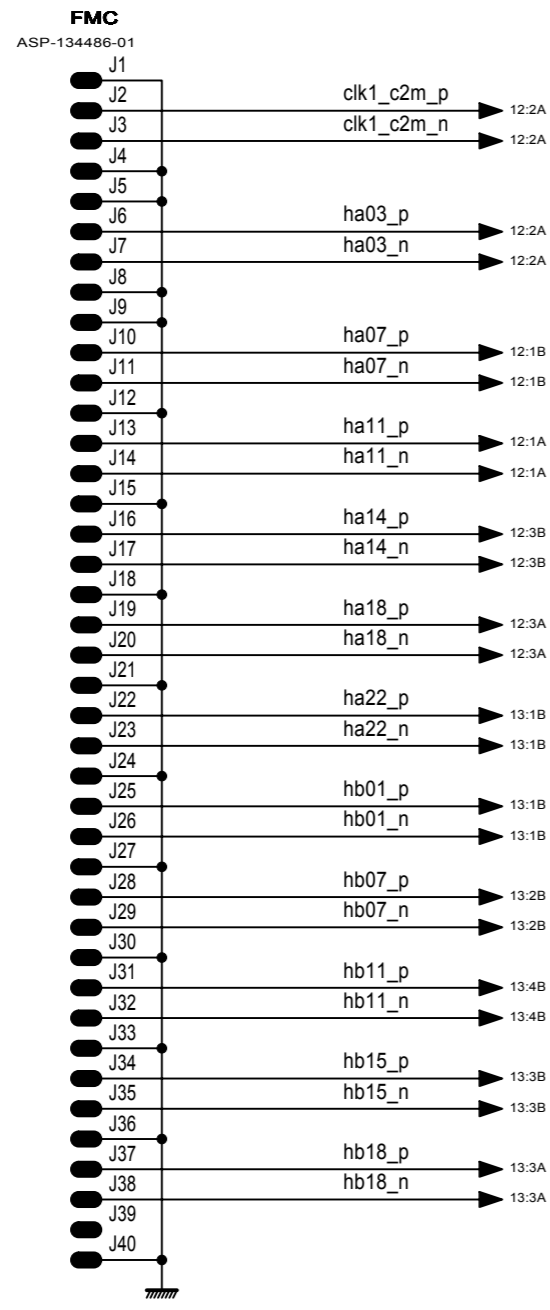

Designer:	Date:	Vérification:	Date:	Approval:	Date:
<b>PLDA GROUP</b> Parc Club du Golf Bâtiment 11 Rue Guillibert 13856 Aix-En-Provence Cedex 3 FRANCE Tel: +33 (0) 442 393 600 Fax: +33 (0) 442 394 902 www.pldagroup.com	Project Name		DESIGNATION		
	XpressK7		FMC J K		
	Product Reference	Page	VERSION		
	P130	27/30	DATE	AUTHOR	INDICE
		19/03/2014	M.C.P.	V.2.2.9	

These schematics are PLDA GROUP property. They must be not reproduced or shared without PLDA GROUP written authorization. Copyright PLDA GROUP 2011. All rights reserved.

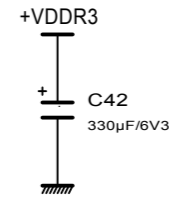
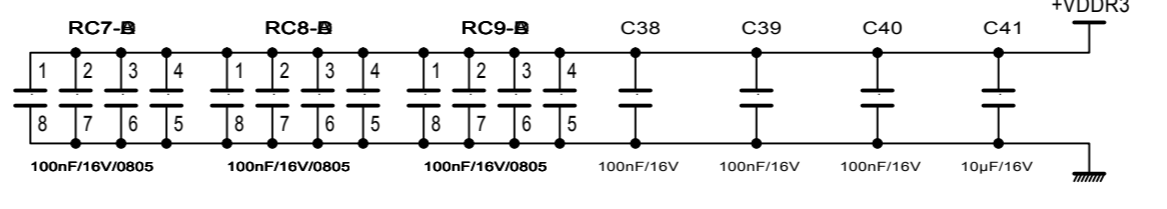
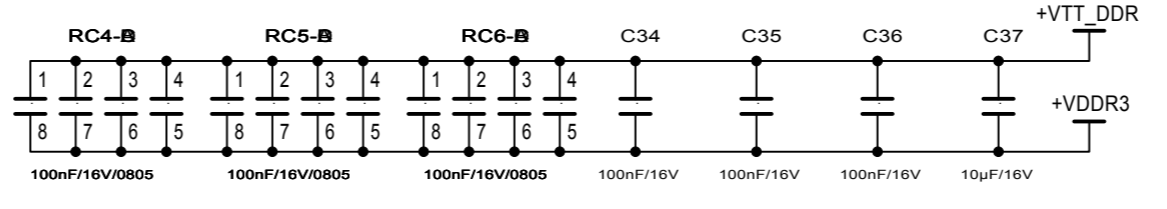
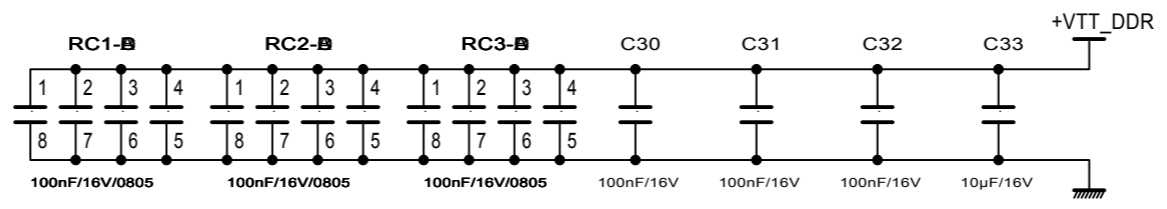
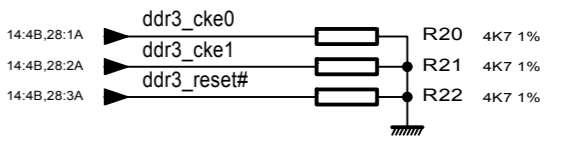
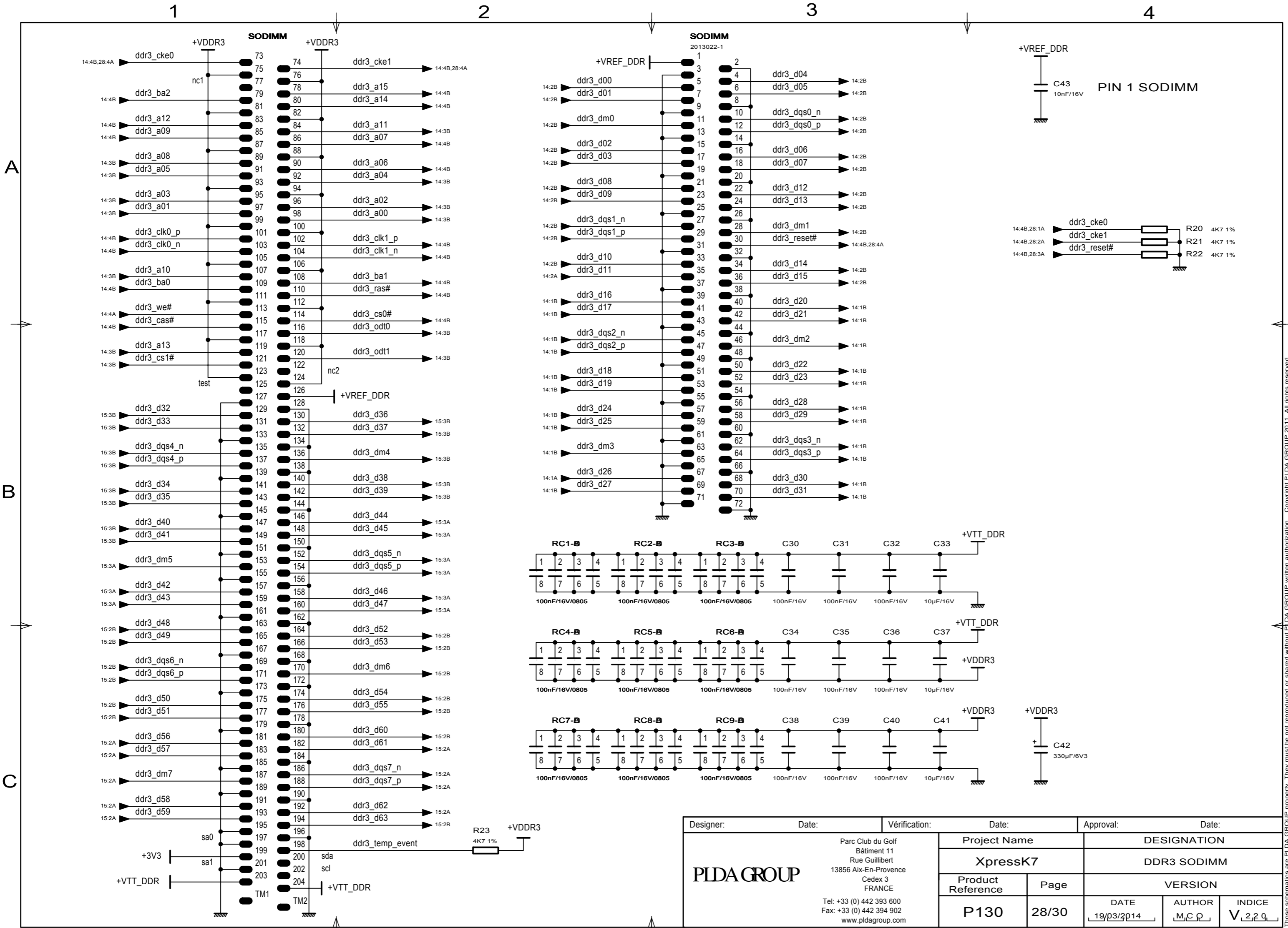

Designer:	Date:	Vérification:	Date:	Approval:	Date:
<b>PLDA GROUP</b> Parc Club du Golf Bâtiment 11 Rue Guillibert 13856 Aix-En-Provence Cedex 3 FRANCE Tel: +33 (0) 442 393 600 Fax: +33 (0) 442 394 902 www.pldagroup.com		Project Name		DESIGNATION	
		XpressK7		DDR3 SODIMM	
Product Reference		Page		VERSION	
P130		28/30		DATE	AUTHOR
				19/03/2014	M.C.P.
				INDICE	V.2.2.9

These schematics are PLDA GROUP property. They must be not reproduced or shared without PLDA GROUP written authorization. Copyright PLDA GROUP 2011. All rights reserved.

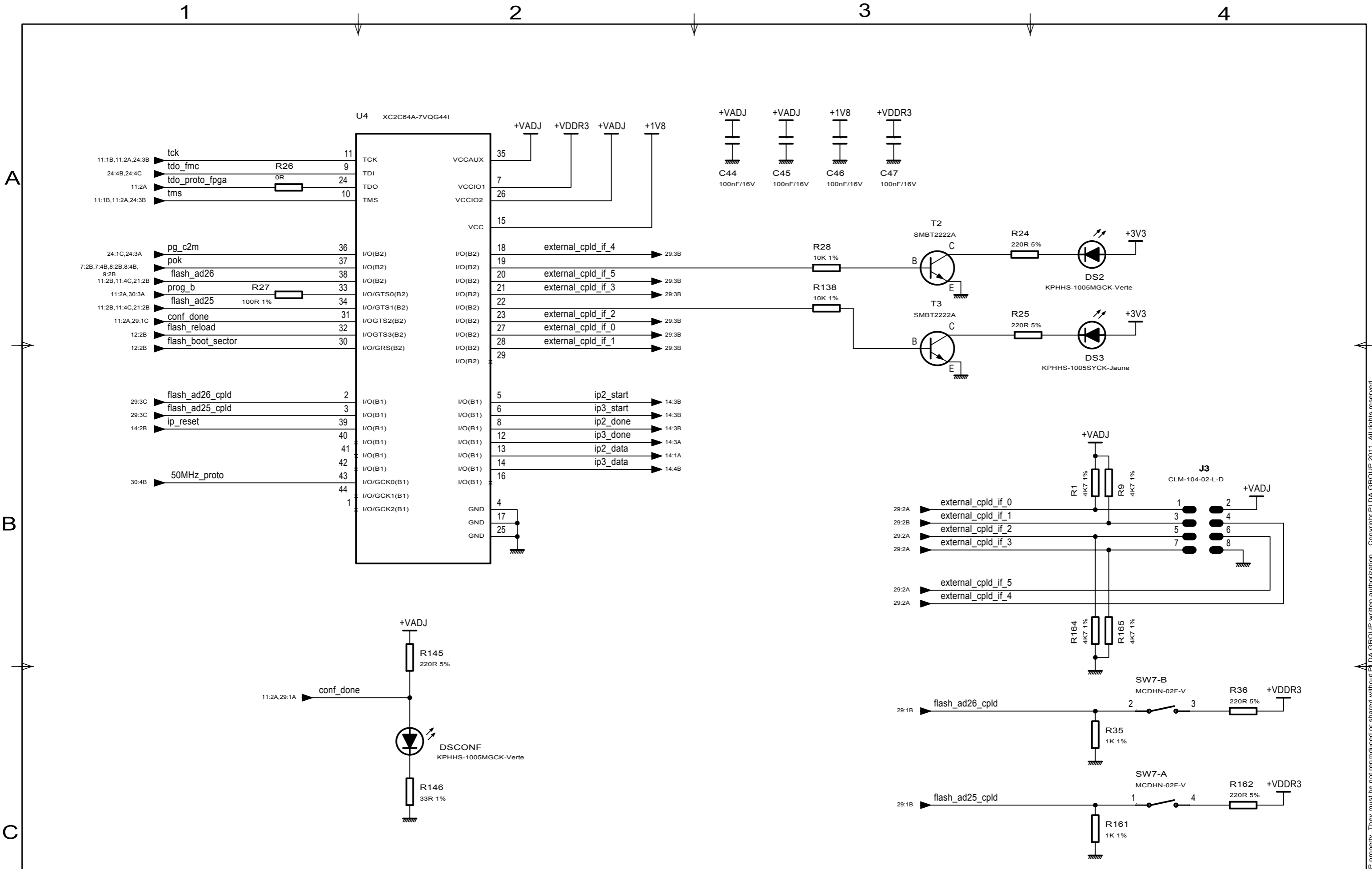

Designer:	Date:	Vérification:	Date:	Approval:	Date:
<b>PLDA GROUP</b>	Parc Club du Golf Bâtiment 11 Rue Guillibert 13856 Aix-En-Provence Cedex 3 FRANCE		Project Name		DESIGNATION
			XpressK7		PROTOCORE
	Product Reference	Page	VERSION		
	P130	29/30	DATE	AUTHOR	INDICE
		19/03/2014	M.C.P.	V.2.2.0	

These schematics are PLDA GROUP property. They must be not reproduced or shared without PLDA GROUP written authorization. Copyright PLDA GROUP 2011. All rights reserved

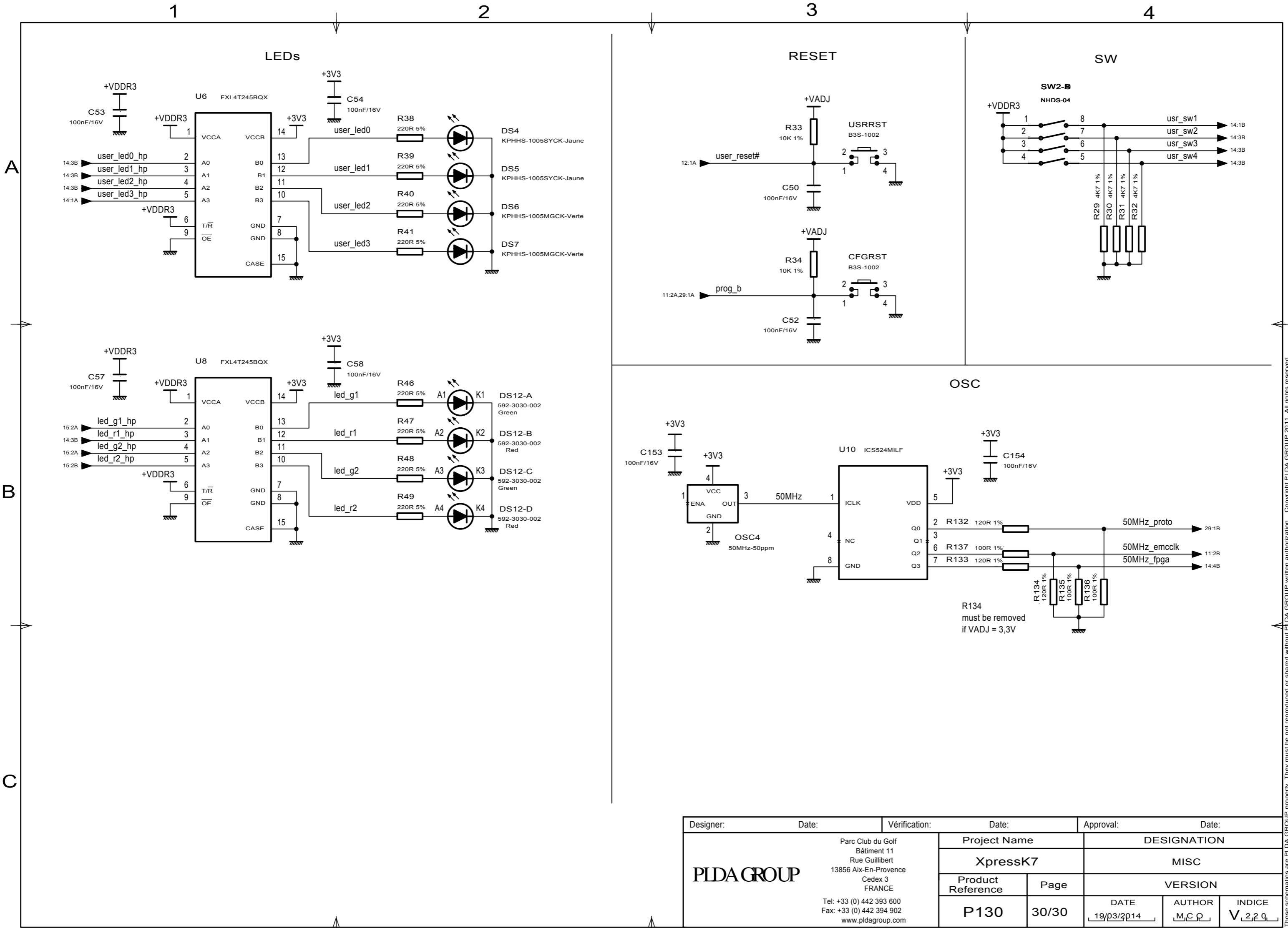

A

B

C

These schematics are PLDA GROUP property. They must be not reproduced or shared without PLDA GROUP written authorization. Copyright PLDA GROUP 2011. All rights reserved

Designer:	Date:	Vérification:	Date:	Approval:	Date:
<b>PLDA GROUP</b> Parc Club du Golf Bâtiment 11 Rue Guillibert 13856 Aix-En-Provence Cedex 3 FRANCE Tel: +33 (0) 442 393 600 Fax: +33 (0) 442 394 902 www.pldagroup.com		Project Name		DESIGNATION	
		XpressK7		MISC	
		Product Reference	Page	VERSION	
P130	30/30	DATE	AUTHOR	INDICE	
		19/03/2014	MJC	V.2.2.9	